

RES-5010 [®] ^{GB}

Operating instructions



Important features

- Microprocessor technology
- Complete control via PROFINET interface ("Conformance Class B", IO / RT acc. to IEC 61784-2) (2 x RJ-45)
- Automatic zero calibration (AUTOCAL)
- Automatic optimization (AUTOTUNE)
- Automatic configuration of the secondary voltage and current ranges (AUTORANGE)
- Automatic phase angle compensation (AUTOCOMP)
- Automatic frequency adjustment
- Large current and voltage range
- Booster connection as standard
- 0...10VDC analog output for ACTUAL temperature
- Alarm function with error diagnosis
- Heatsealing band alloy and temperature range selectable

Contents

1	Safety and warning notes	3	10	Controller functions	22
1.1	Use	3	10.1	LEDs and controls	22
1.2	Heatsealing band	3	10.2	PROFINET communication	24
1.3	Impulse transformer	3	10.3	Device master file (GSDML)	24
1.4	Current transformer PEX-W2/-W3	3	10.4	Communication protocol	25
1.5	Line filter	4	10.5	Input data	25
1.6	Standards / CE marking	4	10.6	Output data	27
1.7	Warranty provisions	4	10.7	Parameter data	29
2	Application	4	10.8	Undervoltage detection	34
3	Principle of operation	5	10.9	Temperature indication (actual value output)	34
4	Description of the controller	6	10.10	Booster connection	35
5	Accessories and modifications	6	10.11	Diagnostic interface / visualization software	36
5.1	Accessories	6	10.12	Total cycle counter	36
5.2	Modifications (MODs)	7	10.13	Operating hours counter	36
6	Technical data	8	10.14	Data memory for error messages and AUTOCAL	36
7	Dimensions	10	10.15	Integrated clock (date and time)	36
8	Installation	11	10.16	System monitoring / alarm output	37
8.1	Installation procedure	11	10.17	Error messages	38
8.2	Installation steps	12	10.18	Fault areas and causes	41
8.3	Power supply	13	11	Factory settings	43
8.4	Line filter	14	12	Maintenance	43
8.5	Current transformer PEX-W3	14	13	How to order	44
8.6	Wiring diagram (standard)	15	14	Index	45
8.7	Wiring diagram with booster connection	16			
9	Startup and operation	17			
9.1	View of the controller	17			
9.2	Controller configuration	17			
9.3	Replacing and burning in the heatsealing band	19			
9.4	Startup procedure	20			

1 Safety and warning notes

This RESISTRON temperature controller is manufactured according to DIN EN 61010-1. In the course of its manufacture it passed through quality assurance, whereby it was subjected to extensive inspections and tests.

It left the factory in perfect condition.

The recommendations and warning notes contained in these operating instructions must be complied with, in order to guarantee safe operation.

The device can be operated within the limits indicated in the "Technical Data" without impairing its operational safety. Installation and maintenance may only be performed by technically trained, skilled persons who are familiar with the associated risks and warranty provisions.

1.1 Use

RESISTRON temperature controllers may only be used for heating and temperature control of heatsealing bands which are expressly suitable for them, and providing the regulations, notes and warnings contained in these instructions are complied with.

 **In case of non-compliance or use contrary to the intended purpose, there is a risk that safety will be impaired or that the heatsealing band, electrical wiring, transformer etc. will overheat. Ensuring such compliance is the personal responsibility of the user.**

1.2 Heatsealing band

A basic prerequisite for reliable and safe operation of the system is the use of suitable heatsealing bands.

 **The resistance of the heatsealing band which is used must have a positive minimum temperature coefficient in order to guarantee trouble-free operation of the RESISTRON temperature controller.**

The temperature coefficient must be specified as follows:

$$TCR \geq 10 \times 10^{-4} \text{ K}^{-1}$$

e.g. Alloy-20: TCR = 1100 ppm/K
NOREX: TCR = 3500 ppm/K

The RESISTRON temperature controller must be set and coded according to the temperature coefficient of the heatsealing band.

 **The use of incorrect alloys with a too low temperature coefficient and incorrect coding of the RESISTRON temperature controller lead to uncontrolled heating and ultimately to burn-out of the heatsealing band!**

The heatsealing bands that were originally supplied must be identified by detail specification, part number or some other means that will assure that replacement bands are identical.

1.3 Impulse transformer

A suitable impulse transformer is necessary to ensure that the control loop functions perfectly. This transformer must be designed according to VDE 0570/EN 61558 (isolating transformer with reinforced insulation) and have a one section bobbin. When the impulse transformer is installed, suitable shock protection must be provided in accordance with the national installation regulations for electrical equipment. In addition, water, cleaning solutions and conductive fluids must be prevented from seeping into the transformer.

 **Incorrect installation of the impulse transformer impairs electrical safety.**

1.4 Current transformer PEX-W2/-W3

The current transformer supplied with the RESISTRON temperature controller is an integral part of the control system.

 **Only the original ROPEX PEX-W2 or PEX-W3 current transformer may be used. Other transformers may cause the equipment to malfunction.**

The current transformer may only be operated if it is connected to the RESISTRON temperature controller correctly (see section 9, "Startup and operation"). The relevant safety instructions contained in section 8.3, "Power supply", must be obeyed. External monitoring modules can be used in order to additionally increase

operating safety. They are not included in the scope of supply of the standard control system and are described in a separate document.

1.5 Line filter

The use of an original ROPEX line filter is mandatory in order to comply with the standards and provisions mentioned in section 1.6 "Standards / CE marking" on page 4. This device must be installed and connected according to the instructions contained in section 8.3, "Power supply" as well as the separate documentation enclosed with the line filter.

1.6 Standards / CE marking

The controller described here complies with the following standards, provisions and directives:

DIN EN 61010-1:2001 (2006/95/EG)	Safety requirements for electrical equipment for measurement, control and laboratory use (low-voltage directive): pollution degree 2, protection class II, measurement category I (for U _R and I _R terminals)
DIN EN 60204-1 (2006/42/EG)	Electrical equipment of machines (machinery directive)
EN 55011:1998 + A1:1999 + A2:2002 EN 61000-3-2:2006-04 EN 61000-3-3:1995-01 + A1:2001 + A2:2005-11 (2004/108/EG)	EMC genery emissions: Group 1, Class A
EN 61000-6-2:2005 (2004/108/EG)	EMC generic immunity: Class A (ESDs, RF radiation, bursts, surges) <u>Exception:</u> Line voltage interruption acc. EN 61000-4-11 is not fulfilled (This leads to a designated error message of the controller)

2 Application

This RESISTRON temperature controller is an integral part of the "5000" series, the key feature of which is its microprocessor technology. All RESISTRON temperature controllers are used to control the temperature of heating elements (heatsealing bands, beaded bands, cutting wires, heatsealing blades,

Compliance with these standards and provisions is only guaranteed if original accessories and/or peripheral components approved by ROPEX are used. If not, then the equipment is operated on the user's own responsibility.

The CE marking on the controller confirms that the device itself complies with the above-mentioned standards.

It does not imply, however, that the overall system also fulfils these standards.

It is the responsibility of the machine manufacturer and of the user to verify the completely installed, wired and operationally ready system in the machine with regard to its conformity with the safety provisions and the EMC directive (see also section 8.3, "Power supply"). If peripheral components (e.g. the transformer or the line filter) from other manufacturers are used, no functional guarantee can be provided by ROPEX.

1.7 Warranty provisions

The statutory provisions for warranties apply for a period of 12 months following the delivery date.

All devices are tested and calibrated in the factory. Devices that have been damaged due to faulty connections, dropping, electrical overloading, natural wear, incorrect or negligent handling, chemical influences or mechanical overloading as well as devices that have been modified, relabeled or otherwise altered by the customer, for example in an attempt to repair them or install additional components, are excluded from the warranty.

Warranty claims must be examined in the factory and approved by ROPEX.

solder elements etc.), as required in a variety of heatsealing processes.

The controller is most commonly used for impulse-heatsealing PE films in:

- Vertical and horizontal f/f/s machines
- Pouch, filling, and sealing machines

- Film wrapping machines
- Pouch making machines
- Group packaging machines
- L-sealers
- etc.

The use of RESISTRON temperature controllers results in:

- Repeatable quality of the heatseals under any conditions
- Increased machine capacity
- Extended life of the heatsealing bands and Teflon coatings
- Simple operation and control of the heatsealing process

3 Principle of operation

The resistance of the heatsealing band, which is temperature sensitive, is monitored 50x per second (60x at 60Hz) by measuring the current and voltage. The temperature calculated with the help of these measurements is indicated and compared with the set point.

The primary voltage of the impulse transformer is adjusted by phase-angle control if the measured values deviate from the set point. The resulting change in the current through the heatsealing band leads to a change in the band temperature and thus also its resistance. This change is measured and evaluated by the RESISTRON temperature controller.

The control loop is closed: ACTUAL temperature = SET temperature. Even minute thermal loads on the heatsealing band are detected and can be corrected quickly and precisely.

A highly dynamic thermoelectric control loop is formed because purely electrical variables are measured at a high sampling rate. A very large secondary current range can be controlled with only minimal power dissipation – a considerable advantage – because power is controlled on the primary side of the

transformer. This allows optimal adaptation to the load and to the required dynamic range despite the controller's exceptionally compact dimensions.

PLEASE NOTE!

RESISTRON temperature controllers play a significant role in enhancing the performance of modern machines. However, the full benefit can only be obtained from the control system's advanced technology if all of the system components – in other words the heatsealing band, the impulse transformer, the wiring, the timing signals, and the controller itself – are fully compatible with one another.

We will be pleased to contribute our many years of experience towards optimizing *your* heatsealing system.

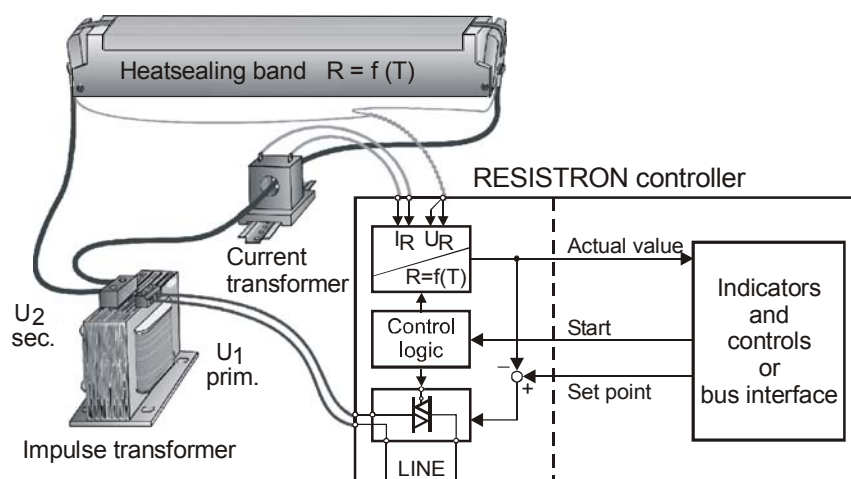

4 Description of the controller

The microprocessor technology enriches the RES-5010 RESISTRON temperature controller with previously unattainable capabilities:

- Very simple operation thanks to AUTOCAL, the automatic zero calibration function.
- Good dynamic response thanks to AUTOTUNE, which automatically adapts to the controlled system.
- High precision thanks to further improved control accuracy and linearization of the heatsealing band characteristic.
- High flexibility: The AUTORANGE function covers a secondary voltage range from 0.4V to 120V and a current range from 30A to 500A.
- Automatic adjustment to the line frequency in the range from 47Hz to 63Hz.
- Increased protection against dangerous conditions such as overheating of the heatsealing band.

The RES-5010 RESISTRON temperature controller is equipped with two PROFINET interfaces. These

interfaces can be used to control all of the controller functions and query controller information.

The ACTUAL temperature of the heatsealing band is supplied to the PROFINET interface and to an analog 0 to 10 V DC output. The real heatsealing band temperature can thus be displayed on an external temperature meter (e.g. ATR-x).

The RES-5010 features an integrated error diagnosis function, which tests both the external system (heatsealing band, wiring etc.) and the internal electronics and outputs a selective error message in case of a fault.

To increase operational safety and interference immunity, all PROFINET signals are electrically isolated from the controller and the heating circuit.

Either coding switches on the temperature controller itself or the PROFINET interface can be used to adapt to different heatsealing band alloys (Alloy 20, NOREX etc.) and set the required temperature range (0...300°C, 0...500°C etc.).



The compact design of the RES-5010 RESISTRON temperature controller and the plug-in connections make this controller easy to install.





5 Accessories and modifications

A wide range of compatible accessories and peripheral devices are available for the RES-5010 RESISTRON temperature controller. They allow it to be optimally adapted to your specific heatsealing application as well as to your plant's design and operating philosophy.

5.1 Accessories

The products described below are only a few of the wide range of accessories available for RESISTRON temperature controllers (↪ "Accessories" leaflet).

	<p>Analog temperature meter ATR-x For front panel mounting or mounting on a top hat rail (DIN TS35 rail). Analog indication of the ACTUAL temperature of the heatsealing band in °C. The meter damping of the unit is optimized for the abrupt temperature changes that occur in impulse mode.</p>
	<p>Line filter LF-xx480 Essential to ensure CE conformity. Optimized for the RESISTRON temperature controller.</p>

	<p>Impulse transformer TR-x Designed according to VDE 0570/EN 61558 with a one-section bobbin. Optimized for impulse operation with RESISTRON temperature controllers. Specified according to the heatsealing application (↪ ROPEX Application Report).</p>
	<p>Communication interface CI-USB-1 Interface for connecting a RESISTRON temperature controller with a diagnostic interface (DIAG) to the PC (USB port). Associated PC visualization software for displaying setting and configuration data as well as for recording SET and ACTUAL temperatures in real time.</p>
	<p>Booster External switching amplifier, necessary for high primary currents (continuous current > 5A, pulsed current > 25A)</p>
	<p>Monitoring current transformer MSW For detecting frame short-circuits on the heatsealing band. Used as an alternative to the standard PEX-W2/W3 current transformer.</p>
	<p>U_R measurement cable UML-1 Twisted cable for measuring the U_R voltage. Suitable for drag chains, contains neither halogens nor silicone.</p>

5.2 Modifications (MODs)

Owing to its universal design, the RES-5010 RESISTRON temperature controller is suitable for a very wide range of heatsealing applications. One modification (MOD) is available for the RES-5010 RESISTRON temperature controller for implementing special applications.

MOD 01

Amplifier for low secondary voltages ($U_R = 0.25 \dots 16 \text{ VAC}$). This modification is necessary, for example, for very short or low-resistance heatsealing bands.

6 Technical data

Type of construction	Housing for installation in the electrical cabinet Snaps onto a standard top hat rail (DIN TS35 rail, 35mm) acc. to DIN EN 50022 Dimensions: 90 x 75mm; height: 135mm (incl. terminals)
Line voltage	115VAC version: 110VAC -15%...120VAC +10% (equivalent to 94...132VAC) 230VAC version: 220VAC -15%...240VAC +10% (equivalent to 187...264VAC) 400VAC version: 380VAC -15%...415VAC +10% (equivalent to 323...456VAC) Depending on the version selected (↪ section 13 "How to order" on page 44)
Power supply system	Balanced TN or TT system, max. 415VAC Installation category III  Operation in a potential-free system (e.g. an IT system) is only permitted after consultation with ROPEX.
Current consumption (primary current of impulse transformer)	$I_{\max} = 5\text{ A}$ (duty cycle = 100%) $I_{\max} = 25\text{ A}$ (duty cycle = 20%)
Line frequency	47...63 Hz, automatic adjustment to frequencies in this range
24VDC supply voltage Terminals 19+20	24VDC, $I_{\max} = 200\text{ mA}$ Tolerance: +10 / -10%
Measuring range	Secondary voltage U_R : 0.4...120VAC Secondary current I_R : 30...500A (with PEX-W2/-W3 current transformer) ↪ ROPEX Application report
PROFINET interface	"Conformance Class B", IO / RT acc. to IEC 61784-2 2 Ethernet switch ports RJ45 Wiring: IEC61784-5-3 Baud rate: 100MHz Data transport layer: Ethernet II, IEEE 802.3 Topology discovery: LLDP, SNMP V1, MIB2, physical device Addressing: DCP or selectable with rotary coding switch FSU (Fast Startup) support: Yes, but startup time approx. 1.5s.
Heatsealing band type and temperature range	The temperature range and temperature coefficient settings can also be specified by means of the ROPEX visualization software (↪ section 10.11 "Diagnostic interface / visualization software" on page 36) in addition to the rotary coding switch or the PROFINET interface (see below): Temperature range: 200°C, 300°C, 400°C, or 500°C Temperature coefficient: 400...4000ppm/K (variable setting range) Five different ranges can be set with the rotary coding switch or via the PROFINET interface: Temperature coefficient 1100ppm/K, 0...300°C (e.g. Alloy 20) Temperature coefficient 780ppm/K, 0...300°C (e.g. Alloy L) Temperature coefficient 1100ppm/K, 0...500°C (e.g. Alloy A20) Temperature coefficient 780ppm/K, 0...500°C (e.g. Alloy L) Temperature coefficient 3500ppm /K, 0...300°C (e.g. NOREX)

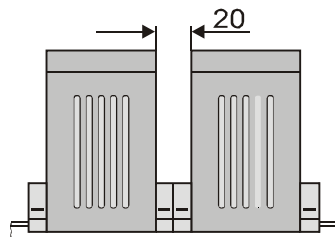
Analog output (actual value) Terminals 17+18	0...10VDC, $I_{max} = 5 \text{ mA}$ Equivalent to 0...300 °C or 0...500 °C Accuracy: $\pm 1\%$ plus 50mV
Fault relay Terminals 12, 13, 14	$U_{max} = 30 \text{ V (DC/AC)}$, $I_{max} = 0.2 \text{ A}$, changeover contact, potential-free
Power dissipation	Max. 20W
Ambient temperature	+5...+45 °C
Degree of protection	IP20
Installation	<p>A minimum safety clearance of 20mm all round (e.g. from other devices and wiring) must be allowed when installing the controller.</p> <p>The moving clip required for fastening must be facing down for mounting on a horizontal top hat rail.</p> <p>End holders to mechanically fix the controller must be fitted at both ends for mounting on a vertical top hat rail.</p> 
Weight	Approx. 0.5kg (incl. connector plug-in parts)
Housing material	Plastic, polycarbonate, UL-94-V0
Connecting cables Type / cross-sections	<p>Rigid or flexible; 0.2...2.5mm² (AWG 24...12) Plug-in connectors</p> <p>Screw terminals: Clamping torque: 0.5...0.6Nm (Screw driver size: SZS 0.6x3.5mm)</p> <p>⚠ If ferrules are used, they must be crimped in accordance with DIN 46228 and IEC / EN 60947-1. This is essential for proper electrical contact in the terminals.</p>

7 Dimensions

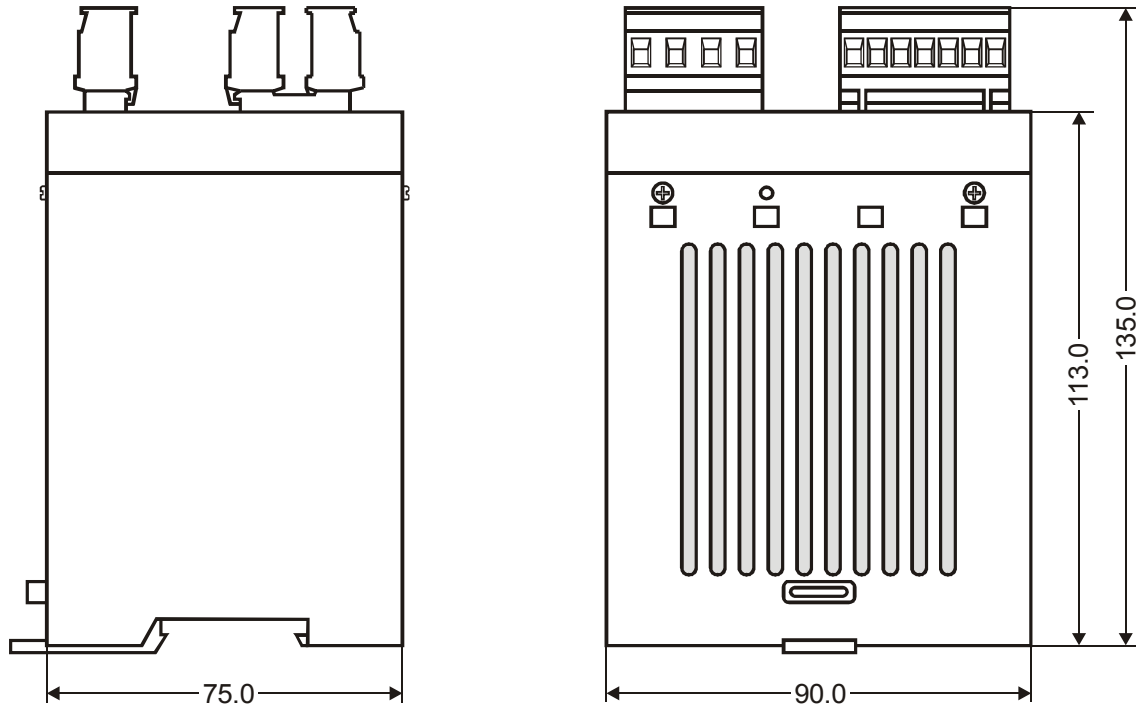

8 Installation

↪ See also section 1 "Safety and warning notes" on page 3.

 **Installation and startup may only be performed by technically trained, skilled persons who are familiar with the associated risks and warranty provisions.**

8.1 Installation procedure

Proceed as follows to install the RES-5010 RESISTRON temperature controller:

1. Switch off the line voltage and verify that the circuit is de-energized.
2. The supply voltage specified on the nameplate of the RESISTRON temperature controller must be identical to the line voltage that is present in the plant or machine. The line frequency is automatically detected by the RESISTRON temperature controller in the range from 47Hz to 63Hz.
3. Install the RESISTRON temperature controller in the electrical cabinet on a standard top hat rail (DIN TS35 rail according to DIN EN 50022). If several controllers are installed on one rail, the minimum clearance specified in section 6 "Technical data" on page 8 must be allowed between them.
4. Wire the system in accordance with the instructions in section 8.3 "Power supply" on page 13, section 8.6 "Wiring diagram (standard)" on page 15, and the ROPEX Application Report. The information provided in section 8.2 "Installation steps" on page 12 must also be heeded.
An overcurrent protective device (e.g. a fuse) with a maximum rating of 10A must be fitted when the controller is installed provided this is adequate for the heatsealing application. If not, two separate overcurrent protective devices should be provided, one for the controller and one for the application (↪ ROPEX Application report).
The minimum possible specification for this device must be entered in the ROPEX Application Report based on the calculated currents. If a larger overcurrent protective device is fitted, you must match the current carrying capacity of the other components accordingly (e.g. cables, impulse transformer etc.).
5. Connect the RESISTRON temperature controller to the PROFINET controller using a cable.
 **Check the tightness of all system connections, including the terminals for the impulse transformer windings.**
6. Make sure the wiring conforms to all relevant national and international installation regulations.

8.2 Installation steps

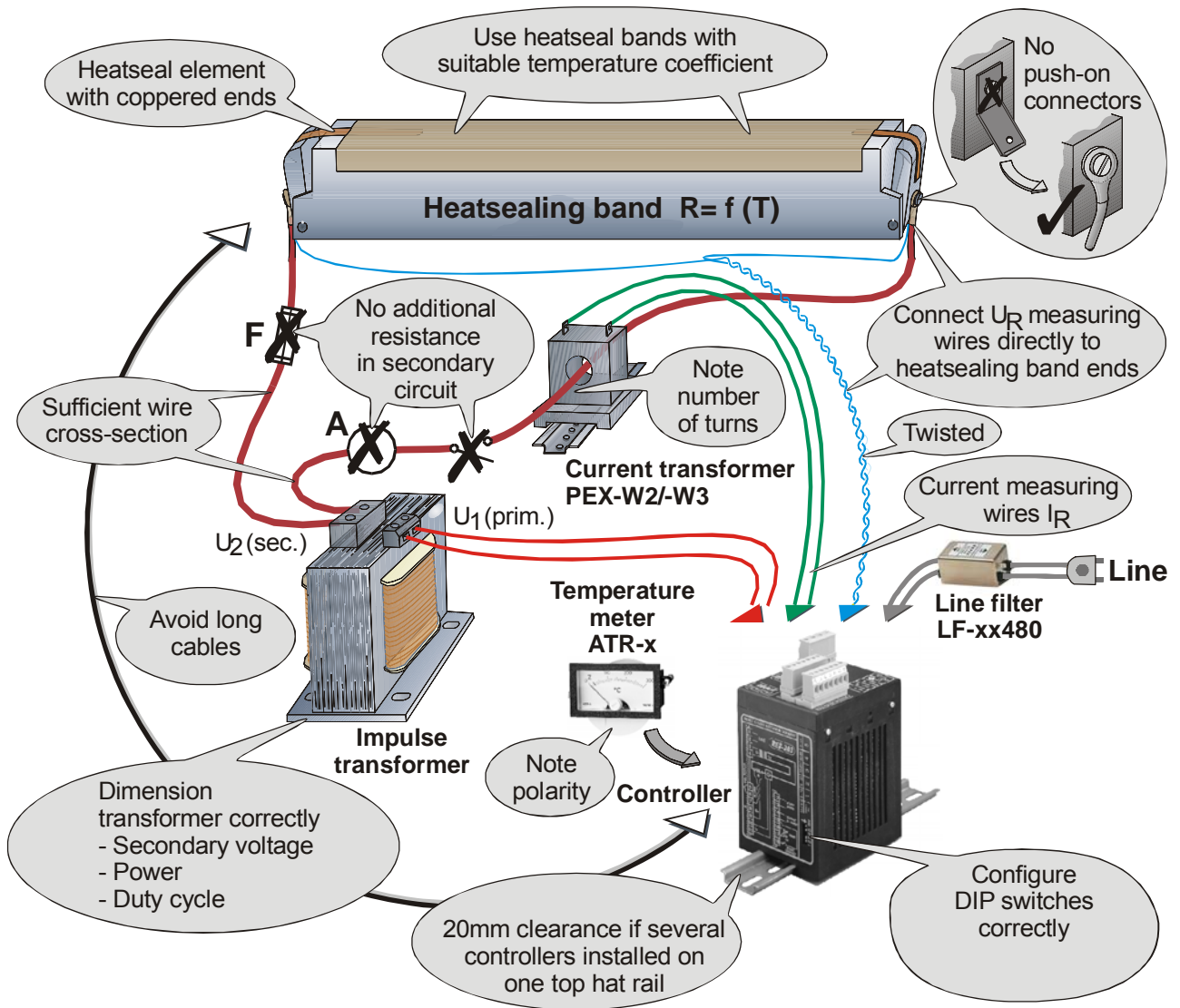

8.3 Power supply

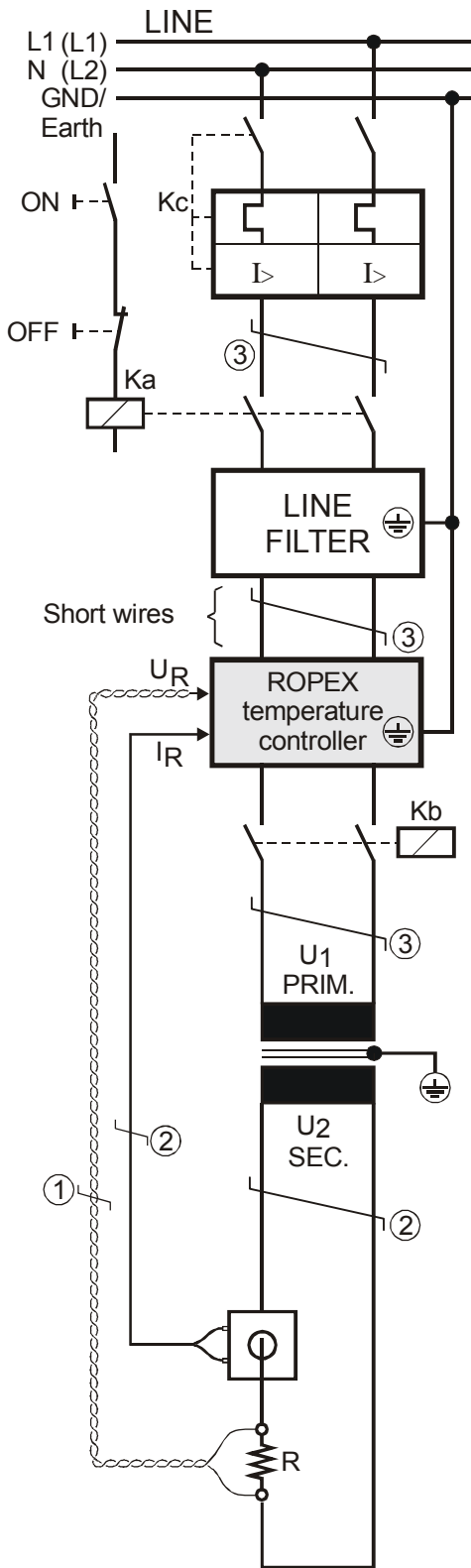

Line

115VAC, 230VAC, 400VAC
50/60Hz

Over-current protection

Double-pole circuit-breaker or fuses,
(☞ ROPEX Application Report)

⚠ Short-circuit protection only.

⚠ RESISTRON temperature controller not protected.

Relay Ka

For "HEAT ON - OFF" function (all-pole) or
"EMERGENCY STOP".

Line filter

The filter type and size must be determined according to
the load, the transformer and the machine wiring
(☞ ROPEX Application Report).

⚠ Do not run the filter supply wires (line side) parallel
to the filter output wires (load side).

RESISTRON temperature controller belonging to the
4xx Series.

Relay Kb

Load break (all-pole), e.g. in combination with the alarm
output of the temp. controller (ROPEX recommendation).

⚠ When using a series resistor RV-....-1 the relay Kb
shall be installed.

Impulse Transformer

Designed according to VDE 0570/EN 61558 (isolating
transformer with reinforced insulation). Connect core to
ground.

⚠ Use transformers with a one section bobbin. The
power, duty cycle and voltage values must be deter-
mined individually according to the application (☞ ROPEX
Application Report and "Accessories" leaflet for impulse
transformers).

Wiring

The wire cross-sections depend on the application
(☞ ROPEX Application Report).

Guide values:

Primary circuit: min. 1.5mm², max. 2.5mm²

Secondary circuit: min. 4.0mm², max. 25mm²

① These wires must always be twisted (>20turns/meter).

② These wires must be twisted (>20turns/meter)

if several control loops are laid together ("crosstalk").

③ Twisting (>20turns/meter) is recommended to
improve EMC.

8.4 Line filter

To comply with EMC directives – corresponding to EN 50081-1 and EN 50082-2 – RESISTRON control loops must be operated with line filters.

These filters damp the reaction of the phase-angle control on the line and protect the controller against line disturbances.

! The use of a suitable line filter is part of the standards conformity and a prerequisite of the CE mark.

installed and wired correctly, they guarantee compliance with the EMC limit values.

You can find the exact specification of the line filter in the ROPEX Application Report calculated for your particular heatsealing application.

For more technical information: ↪ "Line filter" documentation.

! It is permissible to supply several RESISTRON control loops with a single line filter, providing the total current does not exceed the maximum current of the filter.

ROPEX line filters are specially optimized for use in RESISTRON control loops. Providing that they are

The wiring instructions contained in section 8.3 "Power supply" on page 13 must be observed.

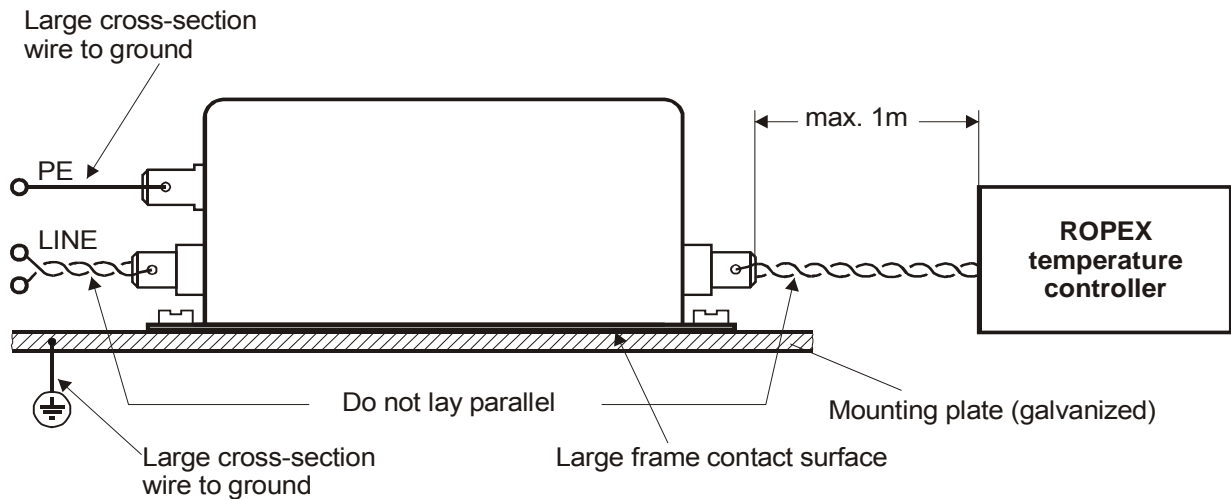

8.5 Current transformer PEX-W3

The PEX-W3 current transformer supplied with the RESISTRON temperature controller is an integral part

of the control system. The current transformer may only be operated if it is connected to the temperature controller correctly (↪ section 8.3 "Power supply" on page 13).

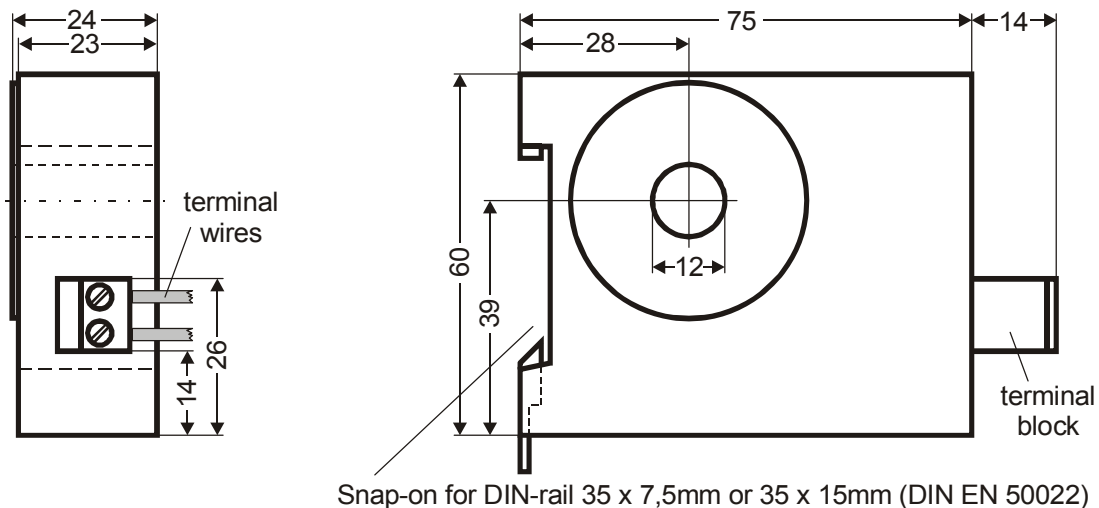

8.6 Wiring diagram (standard)

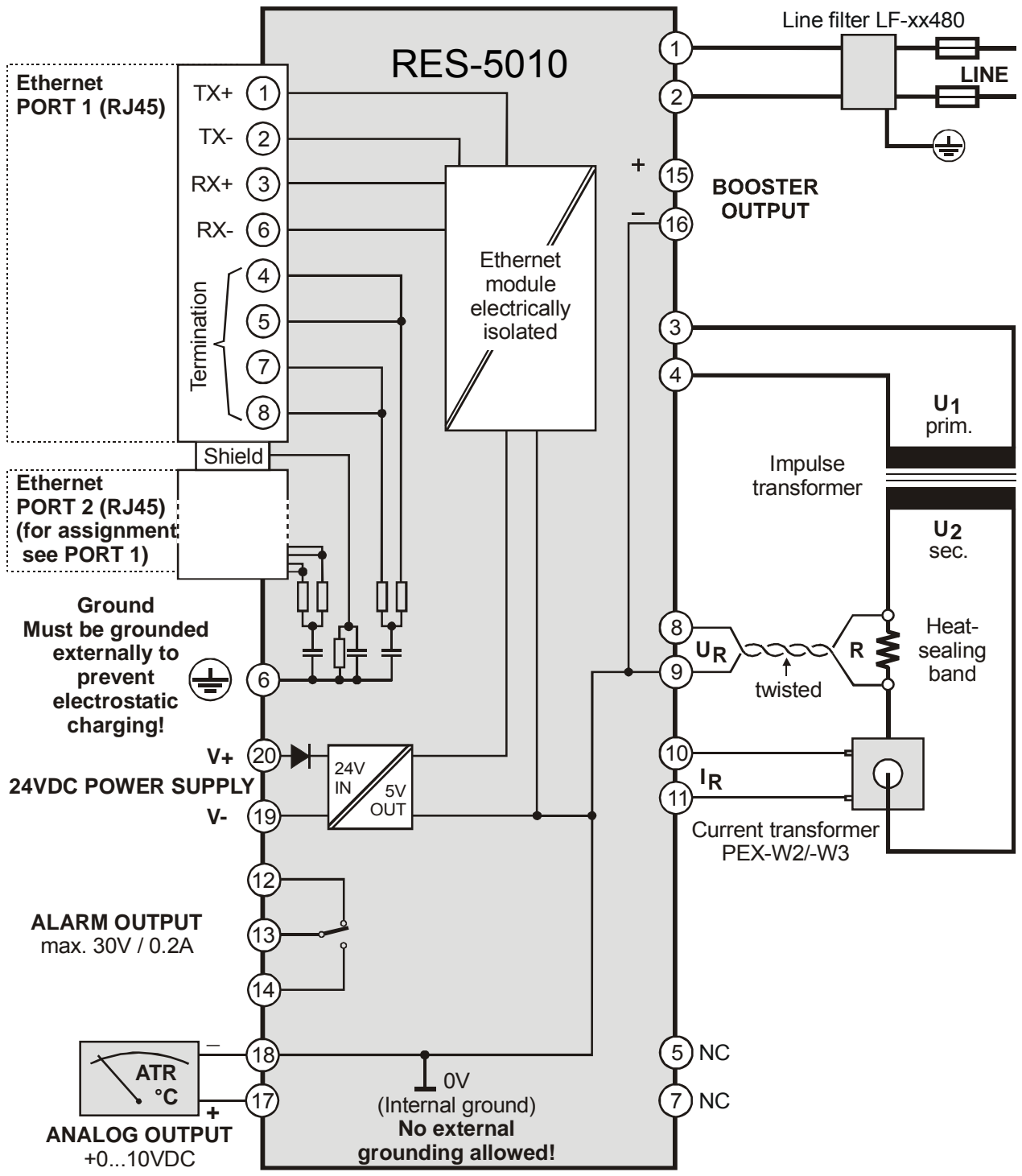

8.7 Wiring diagram with booster connection

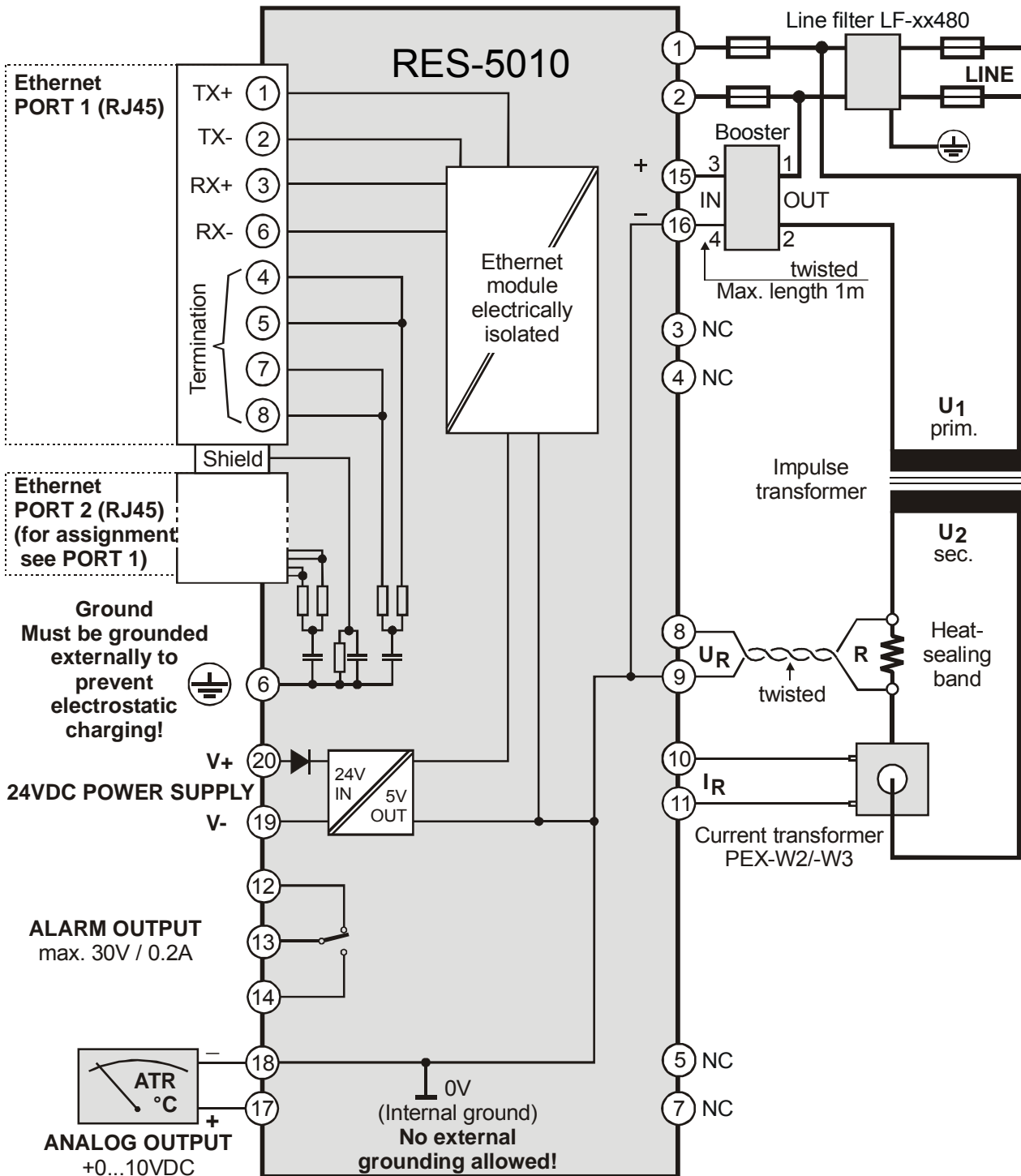

9 Startup and operation

9.1 View of the controller

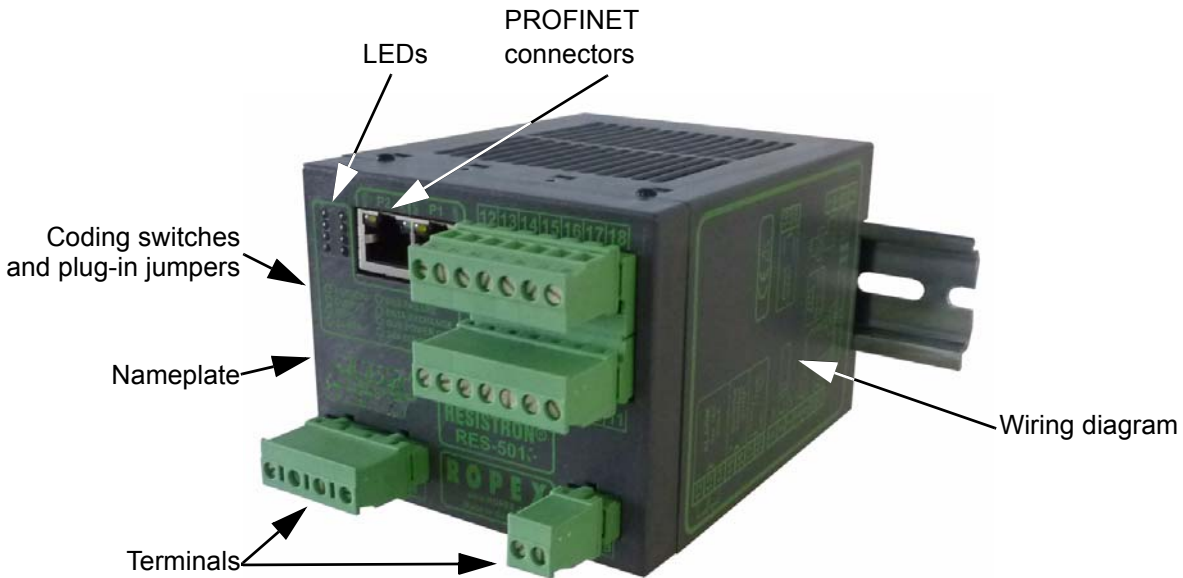

9.2 Controller configuration

 **The controller must be switched off in order to configure the coding switches and plug-in jumpers.**

9.2.1 Configuration of the secondary voltage and current ranges

The secondary voltage and current ranges are automatically configured by the automatic calibration

function (AUTOCAL). The voltage is configured in the range from 0.4VAC to 120VAC and the current in the range from 30A to 500A. If the voltage and / or current are outside of the permissible range, a detailed error message appears on the controller (↪ see section 10.17 "Error messages" on page 38).

If the secondary current I_2 is less than 30A, the secondary high-current wire must be laid twice (or several times) through the PEX-W2 or PEX-W3 current transformer (↪ ROPEX Application Report).



9.2.2 Configuration of the rotary coding switch for the temperature range and alloy

Switch position	Temp. range	Temp. coefficient	Band alloy
0	300°C	1100ppm/K	e.g. Alloy-20
1	300°C	780ppm/K	e.g. Alloy L
4	500°C	1100ppm/K	e.g. Alloy-20
5	500°C	780ppm/K	e.g. Alloy L
8	300°C	3500ppm/K	e.g. NOREX
9	PC-CONFIGURATION		

0 = Factory settings

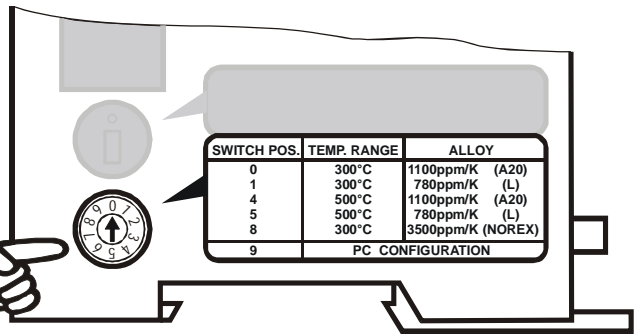

! The setting of the rotary coding switch for the temperature range and alloy can be overwritten with the parameter data (see section 10.7 "Parameter data" on page 29).

If the switch is set to "9", more temperature ranges and alloys can be selected by means of the ROPEX visualization software (see section 10.11 "Diagnostic interface / visualization software" on page 36).

new setting does not take effect until the next time the controller is switched on.

The preset station name "RES-5010" is configured as follows, depending on the settings of the rotary coding switches:

Rotary coding switch	Station name
00	The last name assigned is static
01...FE	RES-5010-01...RES-5010-FE
FF	The last station name assigned and the I&M data are erased

9.2.3 Configuration of the rotary coding switches for station names

These coding switches can be used to set the names of the RES-5010 stations in the PROFINET network. A

Station name selectable.

00 = Factory settings

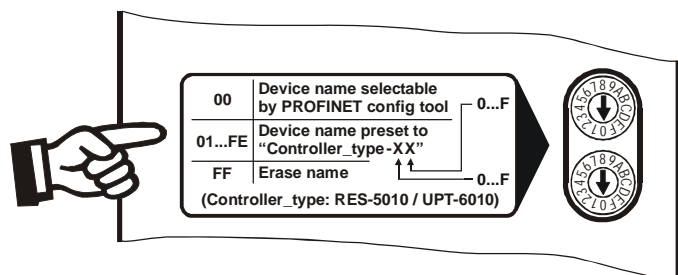
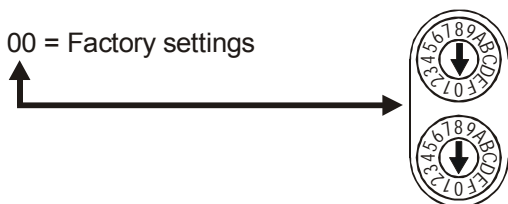

By assigning station names using rotary coding switches, it is possible to replace a device in an existing machine without a programming tool. The replacement device must simply be configured with the same switch settings.

If the RES-5010 was named using a suitable PROFINET tool (e.g. Siemens STEP7), the preset station name can be erased by means of the rotary coding switches. To do this, make sure the controller is

de-energized, then set the switches to 0xFF and switch the controller on again. It is sufficient to supply the controller with 24VDC. No connection to the PROFINET network is required. When the station name has been successfully erased, the DATA EXCHANGE LED (red) blinks at approx. 4Hz. The power supply to the controller must then be momentarily interrupted in order for the new switch settings to take effect.

! In addition to the station name, restoring the controller's factory settings by setting the rotary coding switches to "0xFF" also erases all I&M data in the memory.

! In order to assign the station name via the PROFINET interface (e.g. using a programming tool), the rotary coding switches must be set to "0x00".

Note: By using a configuring tool (e.g. Siemens STEP7) to specify the PROFINET topology, you can also assign names automatically if the controller does not already have a station name when it is switched on. In this case, the PLC automatically assigns it the name stored in the project.

9.2.4 Configuring the fault relay

Alarm relay de-energized by alarm/PC-CONFIGURATION.

Alarm relay energized by alarm.
(factory setting)

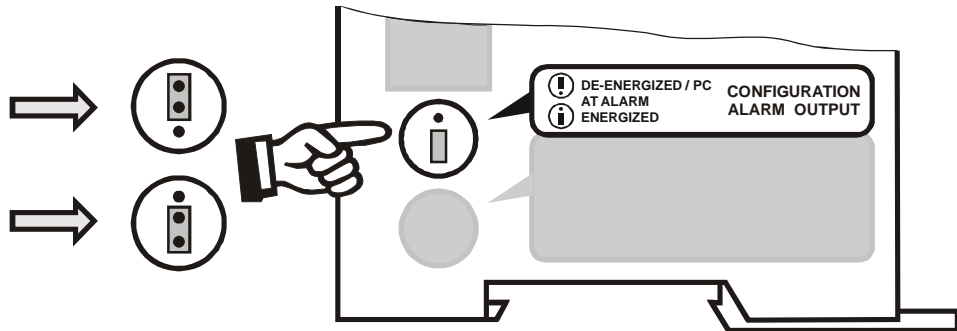

! If the jumper is not inserted – or if it is incorrectly inserted – an error message appears when the controller is switched on (↪ section 10.17 "Error messages" on page 38).

If the "Fault relay de-energized at alarm / PC CONFIGURATION" position is selected, the behavior of the alarm output can be configured in more detail by means of the ROPEX visualization software (↪ see section 10.11 "Diagnostic interface / visualization software" on page 36).

9.3 Replacing and burning in the heatsealing band

9.3.1 Burning in the heatsealing band

The heatsealing band is a key component in the control loop because it is both a heating element and a sensor. The geometry of the heatsealing band is too complex to be discussed at length here. We shall therefore only refer to a few of the most important physical and electrical properties.

The measuring principle applied for this system requires a heatsealing band alloy with a suitable temperature coefficient TCR. Too low a TCR leads to oscillation or uncontrolled heating.

If a heatsealing band with a higher TCR is used, the controller must be calibrated for this.

The first time the heatsealing band is heated to approximately 200...250°C, the standard alloy undergoes a once-only resistance change (burn-in effect). The cold resistance of the heatsealing band is reduced by approximately 2...3%. However, this at first glance slight resistance change results in a zero point

error of 20...30°C. The zero point must therefore be corrected after a few heating cycles, i.e. the AUTOCAL function must be repeated.

The burn-in effect described here does not occur if the heatsealing band has already been thermally pretreated by the manufacturer.

! An overheated or burned-out heatsealing band must no longer be used because the TCR has been irreversibly altered.

One very important design feature is the copper or silver-plating of the heatsealing band ends. Cold ends allow the temperature to be controlled accurately and increase the life of the Teflon coating and the heatsealing band.

9.3.2 Replacing the heatsealing band

All power supply leads must be disconnected from the RESISTRON temperature controller in order to replace the heatsealing band.

! The heatsealing band must be replaced in accordance with the instructions provided by the manufacturer.

Each time the heatsealing band is replaced, the zero point must be calibrated with the AUTOCAL function while the band (and the environment, i.e. silicone, PTFE cover, sealing bar etc.) is still cold in order to compensate production-related resistance tolerances. The burn-in procedure described above should be performed for all new heatsealing bands.

9.4 Startup procedure

Please also refer to section 1 "Safety and warning notes" on page 3 and section 2 "Application" on page 4.

! Installation and startup may only be performed by technically trained, skilled persons who are familiar with the associated risks and warranty provisions.

9.4.1 Initial startup

Prerequisites: The controller must be correctly installed and connected (↪ section 8 "Installation" on page 11). Proceed as follows to start up the controller for the first time:

1. Switch off the line voltage and verify that the circuit is de-energized.
2. The supply voltage specified on the nameplate of the controller must be identical to the line voltage that is present in the plant or machine. The line frequency is automatically detected by the RESISTRON temperature controller in the range from 47...63Hz.
3. Link the device master file (GSDML) into the PROFINET controller (↪ section 10.3), then select the required parameters, assign a name to the device, and start the communication.
4. Make sure the "ST" bit is not set.
5. Switch on the line voltage and the 24VDC auxiliary supply (the order is arbitrary).
6. When the voltage is switched on, the yellow "AUTOCAL" LED lights up for approximately 0.3 seconds to indicate that the controller is being powered up correctly. The "BUS FAILURE" LED (red) lights up as long as no PROFINET communication is active. It does not go out again until it detects an active communication.

! If the red "ALARM" LED lights up for 0.3...1.5s in addition to the yellow "AUTOCAL" LED when the voltage is switched on, the configuration of this controller has been changed by means of the visualization software (↪ section 10.11 "Diagnostic interface / visualization software" on page 36). In order to avoid malfunctions, please check the controller configuration before continuing the startup procedure.

7. The green "DATA EXCHANGE" LED lights up to indicate an active PROFINET communication.
8. One of the following states then appears:

"ALARM" LED	"OUTPUT" LED	ACTION
OFF	Short pulses every 1.2s	Go to 9
BLINKS fast (4Hz)	OFF	Go to 9
LIT continuously	OFF	<u>Error code 901</u> (Error group: 7): No line voltage / sync signal (↪ section 10.2) <u>Otherwise:</u> Error diagnosis (↪ section 10.17)

9. Activate the AUTOCAL function while the heatsealing band is still cold by setting the "AC" bit (AUTOCAL) in the PROFINET protocol (↪ section 10.4 "Communication protocol" on page 25). The yellow "AUTOCAL" LED lights up for the duration of the calibration process (approx. 10...15s). The "AA" bit (AUTOCAL active) is additionally set and a voltage of approx. 0VDC appears at the actual value output (terminals 17+18). If an ATR-x is connected, it indicates 0...3°C.

When the zero point has been calibrated, the "AUTOCAL" LED goes out and a voltage of 0.66VDC (300°C range) or 0.4VDC (500°C range) appears at the actual value output instead. If an ATR-x is connected, it must be set to "Z".

If the zero point has not been successfully calibrated, the "AL" bit (alarm active) is set and the red "ALARM" LED blinks slowly (1Hz). In this case the controller configuration is incorrect (↪ section 9.2 "Controller configuration" on page 17 and ROPEX Application Report). Repeat the

calibration after the controller has been configured correctly.

10. When the zero point has been successfully calibrated, specify a defined temperature by means of the PROFINET protocol (set point) and set the "ST" bit. The "RA" bit (controller active) is then activated and the "HEAT" LED lights up. The heating and control process can be observed at the actual value output.

The controller is functioning correctly if the temperature (which corresponds to the signal change at the analog output or the actual value in the PROFINET protocol) has a harmonious motion, in other words it must not jump abruptly, fluctuate, or deviate temporarily in the wrong direction. This kind of behavior would indicate that the U_R measurement cable has been laid incorrectly.

If an error message is displayed, please proceed as described in section 10.17 "Error messages" on page 38.

11. Burn in the heatsealing band (↪ section 9.3 "Replacing and burning in the heatsealing band" on page 19) and repeat the AUTOCAL function.

The controller is now ready

9.4.2 Restart after replacing the heatsealing band

To replace the heatsealing band, proceed as described in section 9.3 "Replacing and burning in the heatsealing band" on page 19.

 **Always use a heatsealing band with the correct alloy, dimensions, and copper plating in order to avoid malfunctions and overheating.**

Continue with section 9.4, steps 4 to 11.

10 Controller functions

See also section 8.6 "Wiring diagram (standard)" on page 15.

10.1 LEDs and controls

RX/TX (yellow LED)	Lit or blinking if Ethernet frames are transmitted.
LINK (green LED)	Lit if connection exists to Ethernet.

BUS FAILURE (red/green LED)	Lit or blinking if no connection exists to PROFINET.
DATA EXCH (red/green LED)	Lit (green) while data exchange with PROFINET controller.
BUS PWR OK (green LED)	Lit if internal 5VDC power supply for PROFINET interface is OK.
24V SUPPLY (Green LED)	Lit if external 24VDC power supply is present.

AUTOCAL (yellow LED)	Lit while AUTOCAL process is executing.
OUTPUT (Green LED)	Indicates pulses in measurement mode. In control mode, luminous intensity is proportional to heating current.
HEAT (yellow LED)	Lit during heating phase.
ALARM (Red LED)	Lit or blinking to indicate fault.

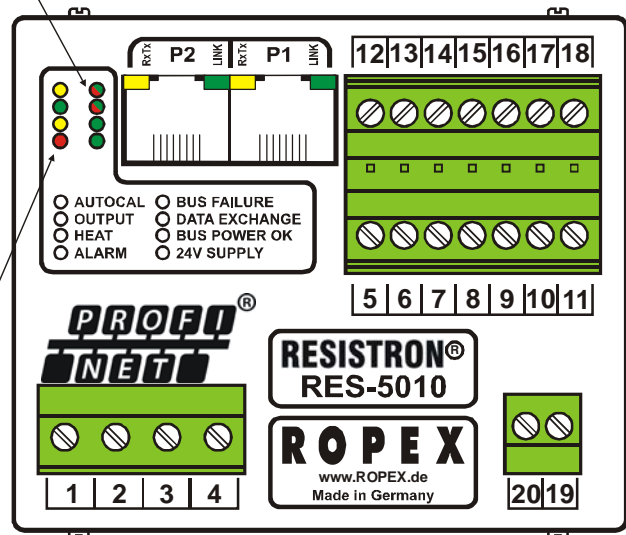

In addition to the functions shown in the diagram above, various controller operating states are indicated

by the LEDs. These states are described in detail in the table below:

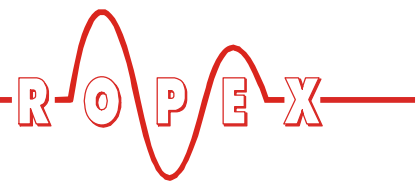

LED	BLINKS slowly (1Hz)	BLINKS fast (4Hz)	Lit continuously
AUTOCAL (yellow)	"RS" bit is set (reset)	AUTOCAL requested but function disabled (e.g. START active)	AUTOCAL executing
	LED blinks with a different frequency: Supply voltages incorrect (too low)		
HEAT (yellow)	—	START requested but function is locked (e.g. AUTOCAL active, set temperature < 40°C)	START executing
OUTPUT (green)	In control mode, the luminous intensity is proportional to the heating current		
ALARM (red)	Configuration error, AUTOCAL not possible	Controller calibrated incorrectly, run AUTOCAL	Error, ↪ section 10.17
DATA EXCHANGE (red / green)	—	Rotary coding switches for station name are set to 0xFF (factory settings restored)	Green: Communication with PROFINET controller is active Red: Internal error in PROFINET module
BUS FAILURE (red / green)	Blinks (red) for 3s at 2Hz: No data exchange Blinks (green or yellow) at 2Hz: DCP signal service activated over the bus		Red: No communication or slow / no physical connection
LINK PORT 1, 2 (green)	—	—	Connection exists to Ethernet
RX / TX PORT 1, 2 (yellow)	The device is transmitting / receiving Ethernet frames		

10.2 PROFINET communication

 The following sections describe only controller-specific functions. For general information about the PROFINET interface and the system configuration, please refer to the description of your PLC.

 The PROFINET interface of the RES-5010 supports "Conformance Class B" with IO/RT according to IEC 61784-2. "Conformance Class C" with IO/RT is not supported.

The controller can communicate via the PROFINET interface provided the 24VDC supply voltage (terminals 19+20) is present.

 However, if the line voltage is not present (e.g. if it is switched off in order to open a door), error code 901 or 201 (error group 7, no line voltage / sync signal) appears on the controller and the fault relay is switched. This error can be reset by switching on the line voltage again and setting the "RS" bit (➔ section 10.5.3 "Reset (RS)" on page 27).

The error code that appears if the line voltage is switched off can be easily processed – and switching of the fault relay suppressed – in the PLC program.

10.3 Device master file (GSDML)

Configuring tools for the PROFINET controller that must be configured interpret the content of the device master files (GSDML) and uses it to create a parameter set for the PROFINET controller which is responsible for useful data communication. The *GSDML-V2.2-ROPEX-0150-RES-5010-20110921.XML* file of the RES-5010 contains all the controller information needed for the configuration, e.g. the I/O data description, parameter descriptions, error messages etc. The device master files and the associated image files (.BMP) (for visualization in the configuring tool) can be requested by e-mail (support@ropex.de) or downloaded from our website (www.ropex.de).

After the required device master file has been linked into the configuring tool, you must assign a unique name to the controller. The controller is not assigned a name at the factory. You must also select the desired parameter values.

10.4 Communication protocol

The communication protocol consists of 2x16 bit input words and 3x16 bit output words (from the point of view of the controller). This protocol separates the set point and the actual value of the RES-5010 from the status

information and the control functions, to enable it to be decoded more easily by the PROFINET controller.



Bits 0...7 form the low byte and bits 8...15 the high byte ("INTEL format").

The 2 x 16-bit **input data** contains the set point in word ① and the control functions in word ②:

①	Spare							Set point / AC temperature									
Name:	0	0	0	0	0	0	0										
Bit no.:	15	14	13	12	11	10	9	8	7	6	5	4	3	2	1	0	

②	Spare												Control function			
Name:	0	0	0	0	0	0	0	0	0	0	0	0	MP	RS	ST	AC
Bit no.:	15	14	13	12	11	10	9	8	7	6	5	4	3	2	1	0

The 3 x 16-bit **output data** contains the actual value in word ①, the status information in word ②, and the error code in word ③:

①	Actual value (signed)															
Name:																
Bit no.:	15	14	13	12	11	10	9	8	7	6	5	4	3	2	1	0

②	Status information																
Name:											WA	AA	AG	AL	TE	TO	RA
Bit no.:	15	14	13	12	11	10	9	8	7	6	5	4	3	2	1	0	

③	Error code																
Name:								A9	A8	A7	A6	A5	A4	A3	A2	A1	A0
Bit no.:	15	14	13	12	11	10	9	8	7	6	5	4	3	2	1	0	

10.5 Input data

The term "input data" refers to the data that is transferred from the PROFINET controller to the

RES-5010. It contains the set point and the control functions, such as START or AUTOCAL for the RES-5010. These functions are explained in the following.

10.5.1 Automatic zero calibration "AUTOCAL" (AC)

Owing to the automatic zero calibration (AUTOCAL) function, there is no need to adjust the zero point manually on the controller. This function matches the controller to the current and voltage signals that are present in the system and calibrates it to the value which is predefined in the parameter data (↪ section 10.7.4 "Variable calibration temperature" on page 30). If no parameter data is transferred by the PROFINET controller, the default value is 20°C.

Some PROFINET controllers do not allow the parameter data to be changed during operation. It is therefore not possible to adapt the calibration temperature to the prevailing ambient conditions in the machines.

The calibration temperature can be specified by means of the "Set point / AC temperature" input data whenever the zero point is calibrated, provided this setting is selected in the parameter data (↪ section 10.7.4 "Variable calibration temperature" on page 30). It can be specified in the 0...+40°C range. The value selected for the calibration temperature must be entered in the "Set point / AC temperature" input data when the "AUTOCAL" function is activated ("AC" bit = 1). This selected value must remain entered until the "AUTOCAL" function has finished.

If the specified temperature is too high (greater than 40°C) or if the selected value varies, an error message appears (error codes 115 and 116; ↪ section 10.17 "Error messages" on page 38).

The AUTOCAL request ("AC" bit = 1) is executed by the controller provided the AUTOCAL function is not disabled.

The automatic calibration takes around 10...15 seconds. The heatsealing band is not heated during this process. The yellow LED on the front panel lights up while the AUTOCAL function is active and the controller reports "AUTOCAL active" ("AA" bit = 1) in the output data. The actual value output (terminals 17+18) is 0...3°C (corresponds to approx. 0VDC).

If the temperature of the heatsealing band varies, the "AUTOCAL" function is executed a maximum of three times. If the function still cannot be terminated successfully, an error message appears (↪ section 10.17 "Error messages" on page 38).

 **The "AUTOCAL" function should only be activated while the heatsealing band (and the environment, e.g. silicone, PTFE cover, sealing bar etc.) is cold (base temperature).**

Reasons for disabled AUTOCAL function:

1. An "AUTOCAL" request cannot be processed until 10 seconds after the controller is switched on. During this time the controller reports "AUTOCAL disabled" ("AG" bit = 1) in the output data.
2. The "AUTOCAL" function is not activated if the heatsealing band cools down at a rate of more than 0.1K/s. If the "AC" bit is set, the function is automatically executed when the cooling rate falls below the above-mentioned value.
3. If the "START" bit ("ST" bit = 1) is set, the AUTOCAL function is not executed ("HEAT" LED lit).
4. If the "RESET" bit ("RS" bit = 1) is set, the "AUTOCAL" function is not executed.
5. The "AUTOCAL" function cannot be activated if error codes 101...103, 201...203, 801 or 9xx occur at startup (↪ section 10.17 "Error messages" on page 38). It cannot be activated with error codes 201...203, 801, or 9xx if the controller has operated correctly at least once since startup.

 **If the AUTOCAL function is disabled ("AG" bit = 1) and you attempt to activate it ("AC" bit = 1), the "AUTOCAL" LED blinks fast (4 Hz).**

10.5.2 Start (ST)

When the "START" bit is set ("ST" bit = 1), the controller's internal set / actual comparison is enabled and the heatsealing band is heated to the SET temperature. It remains at this temperature either until the "ST" bit is reset or until the actual heating time exceeds the preset heating time limit (↪ section 10.7.5 "Heating time limit" on page 31).

The "HEAT" LED on the front panel of the RES-5010 lights up continuously for the duration of the heating time.

A start request is not processed if the AUTOCAL function is active, the controller has reported a fault, the set point is less than 40°C or the "RS" bit is set. In all of these cases the "HEAT" LED blinks.

The heatup process is terminated if the "ST" bit is reset or if a PROFINET error is signaled.

 **The "ST" bit is only accepted if the AUTOCAL function is deactivated and there are no faults.**

The fault relay is switched if the "ST" bit is set while a warning message is indicating error codes 8...12 (104...106, 111...114, 211, 302, or 303) (↪ section 10.17 "Error messages" on page 38). The heatsealing band is no longer heated.

10.5.3 Reset (RS)

This bit resets the controller if the controller reports a fault.

No AUTOCAL or START requests are accepted as long as the "RS" bit is set. Until it is reset again, only error codes 5 and 7 (201...203, 901, 913) are evaluated and output by the error diagnosis function. The power section is not activated in this state and no measuring impulses are generated. As a result of this, the actual value is no longer updated. The reset request is not processed until the "RS" bit is reset. The PROFINET communication is not interrupted by a controller reset. The controller simply requests the parameter data from the PROFINET controller again. The controller actual value output changes to 0...3°C (i.e. approximately 0VDC) while the "RS" bit is being set. This may be interpreted by the higher-level controller (e.g. a PLC) as feedback.

The "AUTOCAL" function is not aborted if the "RS" bit is set while it is still executing.

! The controller performs an internal initialization lasting approximately 500ms after the "RS" bit is reset. The next heatsealing process cannot be started until it has finished.

! If a contactor Kb is used to deactivate the control loop (↪ section 8.3 "Power supply" on page 13), it must be energized again 50ms at the latest after the "RS" bit is reset. If it is energized too late, an error message will be output by the controller.

10.5.4 Measurement pause (MP)

No more measuring impulses are generated by the controller as soon as the "MP" bit is set. Until it is reset again, only error codes 5 and 7 (201...203, 901, 913) are evaluated and output by the error diagnosis function. In addition, the actual value is no longer updated. The last valid value before the bit was set is

output. As soon as the bit is reset, new measuring impulses are generated, all error messages are evaluated, and the actual value is updated again.

This bit is only active in measuring mode. "ST", "RS", and "AC" take priority.

The bit is suitable for all applications in which the electrical connections of the heatsealing band need to be disconnected during normal operation without triggering a fault (e.g. sliding rail contacts).

In contrast to the "RS" bit (RESET), the "MP" bit does not reset any fault signals when it is set. The controller is activated again as soon as the bit is reset, in other words there is no initialization phase.

! When the controller is started, it only evaluates the "MP" bit if the system test (including the functional test of the heating circuit) is successful. This can take several hundred milliseconds.

10.5.5 Set point

A set point of up to 300 °C or 500 °C is allowed, depending on the selected temperature range (↪ section 10.7.1 "Temperature range and alloy" on page 30). If you attempt to enter a higher set point, it is limited internally to 300 °C or 500 °C.

10.6 Output data

The term "output data" refers to the data that is transferred from the RES-5010 to the PROFINET controller. It contains the current actual value and all important information about the momentary status of the controller. If a fault is signaled, it can be diagnosed accurately with the help of the error code.

10.6.1 AUTOCAL active (AA)

The "AA" bit indicates that the AUTOCAL function is currently executing.

10.6.2 AUTOCAL disabled (AG)

If the "AG" bit is set, the AUTOCAL function is temporarily disabled. This is the case if "START" is active or if the heatsealing band is still in the cooling phase.

10.6.3 Fault active (AL)

If the "AL" bit is set, a fault has been triggered but not yet reset. The error code provides information about the exact cause of the fault (↪ section 10.17 "Error messages" on page 38).

10.6.4 Warning active (WA)

This bit can be set in addition to the "AL" bit. If the "WA" bit is set, a warning is output for the current fault. In this case, the fault relay is not active.

10.6.5 Temperature reached (TE)

The "TE" bit is set if the actual temperature exceeds 95% of the set temperature. As soon as the control mode is exited ("ST" bit = 0) or a fault is signaled ("AL" bit = 1), this status bit is reset again.

10.6.6 Temperature OK (TO)

The RES-5010 checks whether the actual temperature is within a settable tolerance band ("OK" window) either side of the set temperature. The lower ($\Delta\vartheta_{lower}$) and upper ($\Delta\vartheta_{upper}$) limits of the tolerance band can be changed independently of one another by means of the parameter data (↪ section 10.7 "Parameter data" on page 29). The following settings are possible:

1. "Off"
The "TO" bit is always reset.
2. "Active if Tact = Tset" (factory setting)
The "TO" bit is set if the actual value is inside the specified temperature tolerance band. If the actual temperature is outside of the tolerance band, the "TO" bit is reset (see graph below).

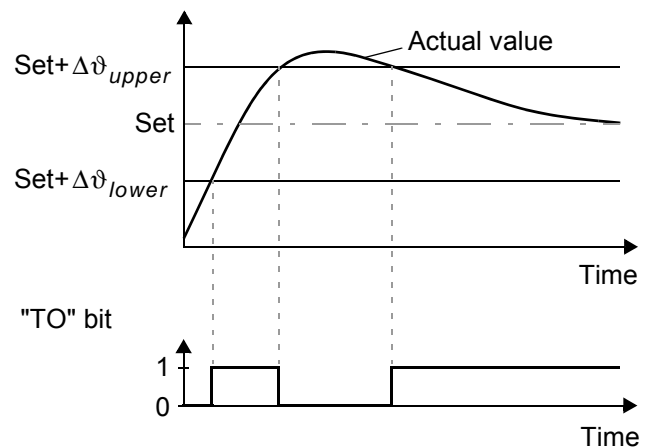

Unlike the "Temperature reached" status bit ("TE" bit), the actual temperature is evaluated independently of the control mode.

3. "Active if Tact = Tset" with latch function

A heatsealing cycle starts when the "ST" bit is set. The "TO" bit is set when the actual temperature reaches the temperature tolerance band for the first time during a heatsealing cycle. If the actual temperature leaves the tolerance band again –while the "ST" bit is still set– the "TO" bit is reset (refer to Fig.a.). If the actual temperature does not leave the tolerance band –while the "ST" bit is still set– the "TO" bit is not reset until the start of the next heatsealing cycle (latch function, refer to Fig.b.). The switching state of the "TO" bit can thus be queried after the "ST" bit has been reset and before the start of the next heatsealing cycle.

a.) Temperature *not* OK

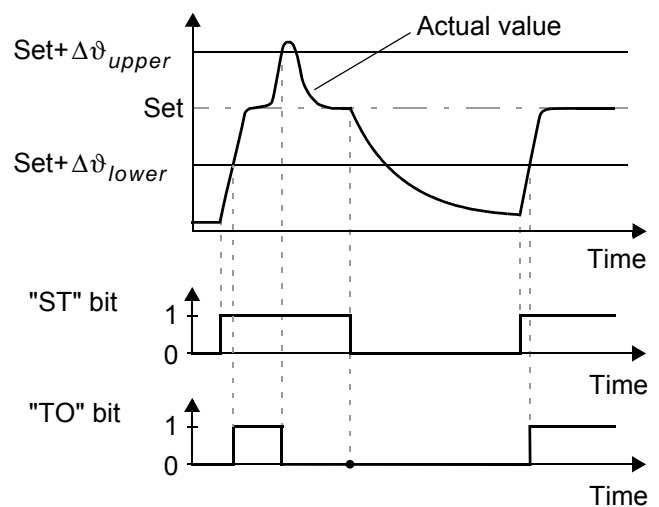

b.) Temperature OK

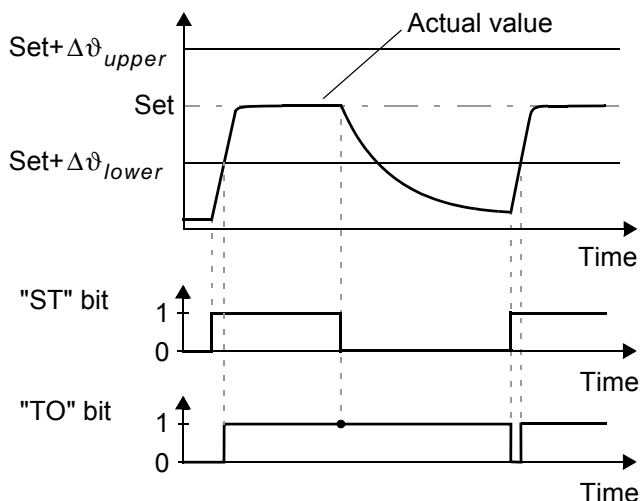

! The limits of the tolerance band are adjustable up to a maximum of +99 K.

10.6.7 Controller active (RA)

The RES-5010 has successfully processed the "START" request and entered control mode if the "RA" bit = 1.

10.6.8 Actual value

All 16 bits of the first word must be interpreted as a signed number (twos complement notation). During the calibration procedure or if a fault is signaled, the actual value is 0.

10.6.9 Error codes

If a fault is signaled ("AL" bit = 1), the error code allows the exact cause to be determined. The error code is contained in the third word at bit positions 0...9 (↪ section 10.17 "Error messages" on page 38).

In addition to the error codes, the PROFINET diagnosis function also sends error messages to the PROFINET controller. The error messages corresponding to each error code are already stored in the device master file (GSDML), so that they automatically appear in plain text on the PROFINET controller whenever the device diagnosis for the RES-5010 is queried there. The error messages are stored in the GSDML file in English and German. You can select the required language in the configuration tool.

10.7 Parameter data

The parameter data contains values for selecting the heatsealing band alloy, the temperature range, the upper and lower tolerance band limits for temperature monitoring, the calibration temperature, and the optional heating time limit. It is transferred from the PROFINET controller to the RES-5010 each time the system is started up. The parameters can also be queried by the PROFINET controller or sent by it to the RES-5010 at any time by means of asynchronous read/write services. They are not stored in the RES-5010. The parameter data can be addressed at slot 1, subslot 1, starting at index 4 and has the following structure:

Index	Function	De-fault value ¹	Value range
4	Temperature range / alloy	10	0, 1, 4, 5, 8, 10, 11 (↪ 10.7.1)
5	Lower temperature OK threshold	10K	3...99K
6	Upper temperature OK threshold	10K	3...99K
7	Calibration temperature	20°C	-1, 0...40°C
8/9	Heating time limit (100ms steps)	0	0...999 (0...99.9s)
10	External module / channel errors	On	Off, on
11	Measuring impulse duration	17	17...30 (1.7...3.0ms)
12	Data format	Little Endian (Intel)	Little Endian (Intel), Big Endian (Motorola)
13/14	Temperature coefficient	1100p pm/K	400... 4000ppm/ K
15	Temperature range	300°C	200, 300, 400, 500°C

Index	Function	Default value ¹	Value range
16/17	Maximum temperature	300 °C	200...500 °C
18	Temperature diagnosis	Off	Off, on
19	Temperature diagnosis delay time (100 ms steps)	0 s	0...99 (0...9.9s)
20/21	Heatup timeout (100ms steps)	0 s	0...999 (0...99.9s)
22	AUTOCOMP	Off	Off, on, auto
23	Temperature OK bit	Active if Tact=Tset	Off, active if Tact=Tset, active if Tact=Tset with latch
24	Hold mode	Off	Off, on, 2s

1. The default value is stored in the device master file (GSDML) and transferred from the PROFINET controller to the RES-5010 when the system is started up.

10.7.1 Temperature range and alloy

This parameter selects both the temperature range and the heatsealing band alloy. You can overwrite the setting of the rotary coding switch by changing the default value (10) (↪ section 9.2.2 "Configuration of the rotary coding switch for the temperature range and alloy" on page 18).

Value	Temperature range	Alloy
0	300 °C	TCR = 1100ppm/K, e.g. Alloy 20
1	300 °C	TCR = 780ppm/K, e.g. Alloy L
4	500 °C	TCR = 1100ppm/K, e.g. Alloy 20
5	500 °C	TCR = 780ppm/K, e.g. Alloy L

Value	Temperature range	Alloy
8	300 °C	TCR = 3500 ppm/K, e.g. NOREX
9	PC configuration (ROPEX visualization software)	PC configuration (ROPEX visualization software)
10	Rotary coding switch setting	Rotary coding switch setting
11	Variable: Parameter index 15 is used	Variable: Parameter index 13/14 is used Parameter instance 8 is used

Setting 11 applies the value stored in parameter index 15 to the temperature range and the value stored in parameter index 13/14 to the alloy.

 **You must always execute the AUTOCAL function after changing the "Temperature range/alloy", "Temperature range", or "Temperature coefficient" parameter.**

10.7.2 Lower temperature OK threshold

Lower threshold value for the "OK" window. Refer to section 10.6.6 "Temperature OK (TO)" on page 28 and section 10.7.10 "Temperature diagnosis" on page 32.

10.7.3 Upper temperature OK threshold

Upper threshold value for the "OK" window. Refer to section 10.6.6 "Temperature OK (TO)" on page 28 and section 10.7.10 "Temperature diagnosis" on page 32.

10.7.4 Variable calibration temperature

The calibration temperature is set to 20 °C as default. You can change it to another value between 0 °C and 40 °C in order to adapt it to the temperature of the cold heatsealing band.

Some PROFINET controllers do not allow the parameter data to be changed during operation. It is therefore not possible to adapt the calibration temperature to the prevailing ambient conditions in the machines.

The calibration temperature can be activated for setting by means of the input data by selecting the value "-1" in

the parameter data. The calibration temperature can then be specified via the "Set point / AC temperature" input data (↪ section 10.5.1 "Automatic zero calibration "AUTOCAL" (AC)" on page 26).

! You do not need to execute the AUTOCAL function after changing the calibration temperature.

10.7.5 Heating time limit

The heating time limit provides additional protection against unwanted permanent heating. The controller automatically deactivates the heating impulse after the set heating time limit has elapsed if the start bit remains set for longer than the time specified by this limit. The start bit must be reset before the controller can be started up again.

The heating time limit is deactivated as default (0) but can be set to any value between 0s and 99.9s (0 and 999).

10.7.6 External module / channel errors

The controller diagnosis uses the diagnostic function of the PROFINET protocol to display several errors of the RES-5010 directly on the PROFINET controller. There is a text message stored in the device master file (GSDML) for each error which is automatically displayed in plain text on the PROFINET controller provided the controller has this capability.

The display of external module / channel errors can be activated or deactivated by means of the parameter at index 9. The default setting for external module / channel errors is "on".

You can query the controller status by means of the user data regardless of this parameter.

10.7.7 Measuring impulse duration

The length of the measuring impulses generated by the controller can be set by means of the parameter at index 10. It may be necessary to set a measuring impulse that is longer than the default 1.7 ms for certain applications.

10.7.8 Data format

This parameter specifies the order of the bytes ("Little Endian (Intel)", "Big Endian (Motorola)") in the cyclic data for both input and output data (↪ section 10.4 "Communication protocol" on page 25). We recommend setting "Big Endian (Motorola)" for Siemens PLCs.

10.7.9 Automatic phase angle compensation (AUTOCOMP)

It may be necessary to compensate the phase angle displacement between the U_R and I_R measuring signals for special heatsealing applications (↪ ROPEX Application Report). The "AUTOCOMP" function is provided for this purpose. The following settings are possible:

1. "Off" (factory setting)
The "AUTOCOMP" function is switched off.
2. "On"
The "AUTOCOMP" function is executed whenever the "AUTOCAL" function ↪ section 10.5.1 "Automatic zero calibration "AUTOCAL" (AC)" on page 26) is executed twice in quick succession. The interval between the end of the first "AUTOCAL" function and the start of the second "AUTOCAL" function must be shorter than 2.0s. The second "AUTOCAL" function only takes around 2.0s and incorporates the "AUTOCOMP" function.
If the interval between the two "AUTOCAL" functions is longer than 2.0s, "AUTOCAL" is executed normally again the second time.

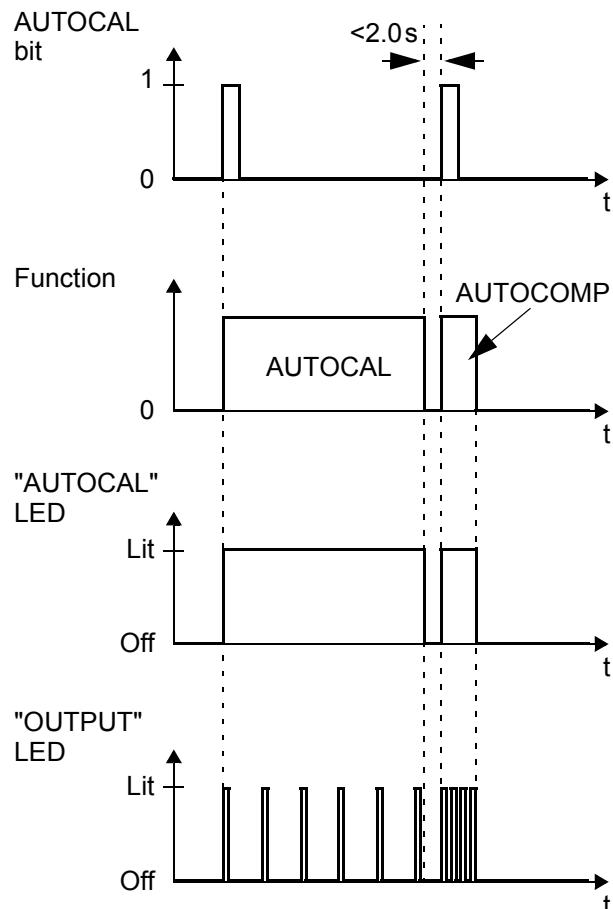

The "OUTPUT" LED blinks repeatedly when the "AUTOCOMP" function is executed and the actual value output (terminals 17+14) is set to 0...3°C (i.e. approx. 0VDC).

3. „AUTO“

This setting causes the "AUTOCOMP" function to be automatically activated after the "AUTOCAL" function has been successfully executed.

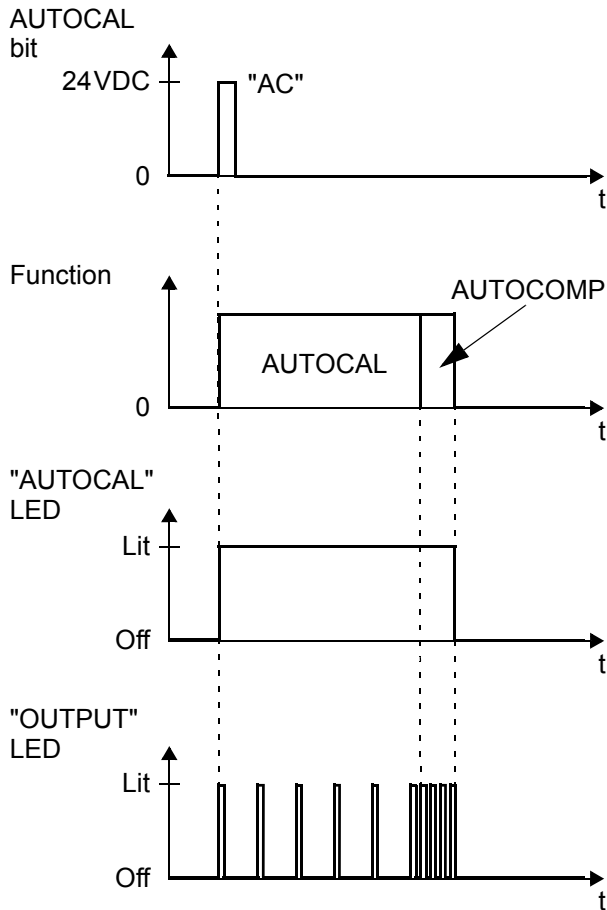

The "OUTPUT" LED blinks repeatedly when the "AUTOCOMP" function is executed and the actual value output (terminals 17+14) is set to 0...3°C (i.e. approx. 0VDC).

⚠ The "AUTOCOMP" function must be activated by means of the parameter data (↪ section 10.7 "Parameter data" on page 29) (default setting: AUTOCOMP off).

10.7.10 Temperature diagnosis

An additional temperature diagnosis can be activated by means of the parameter data (device master file). The RES-5010 checks whether the ACTUAL temperature is within a settable tolerance band ("OK"

window) either side of the SET temperature. The lower ($\Delta\vartheta_{lower}$) and upper ($\Delta\vartheta_{upper}$) tolerance band limits are the same as for the "Temperature OK" function ("TO" bit ↪ section 10.6.6 "Temperature OK (TO)" on page 28). The limits are configured to -10K and +10K at the factory.

If the ACTUAL temperature is inside the specified tolerance band when the "START" signal is activated, the temperature diagnosis is activated as well. If the ACTUAL temperature leaves the tolerance band, the corresponding error code (307,308) is indicated and the fault relay is switched (↪ section 10.17 "Error messages" on page 38).

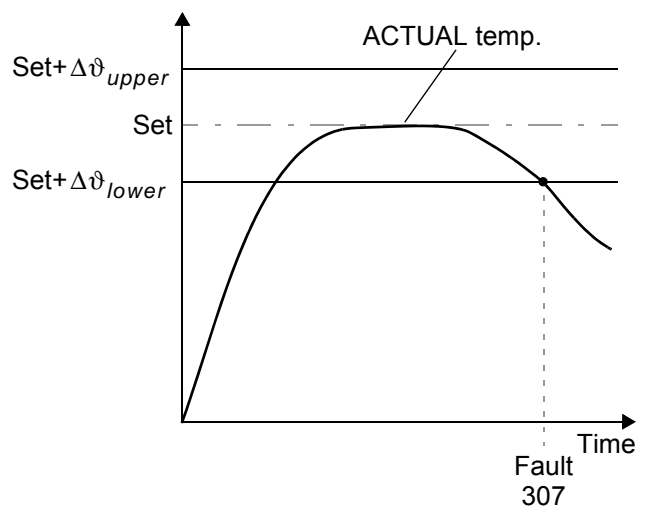

If the temperature diagnosis is not activated by the time the "START" signal is deactivated (i.e. if the ACTUAL temperature does not exceed the upper or lower tolerance band limit), the corresponding error code (309, or 310) is indicated and the fault relay is switched. An additional delay time (0..9.9s) can be set by means of the parameter data (device master file). The first time the lower tolerance band limit is exceeded, the temperature diagnosis is not activated until the parameterized delay time has elapsed. The temperature diagnosis function can thus be explicitly deactivated, e.g. if the temperature drops temporarily owing to the closure of the sealing jaws.

⚠ The lower and upper tolerance band limits cannot be set using the ROPEX visualization software. The same limits apply as for the "TO" bit. They can only be set by means of the parameter data (↪ section 10.7 "Parameter data" on page 29).

10.7.11 Heatup timeout

An additional heatup timeout can be activated by means of the parameter data (device master file).

This timeout starts when the "ST" bit is set. The RES-5010 then monitors the time required for the ACTUAL temperature to reach 95% of the SET temperature. If this time is longer than the parameterized time, the corresponding error code (304) is indicated and the fault relay is switched (☞ section 10.17 "Error messages" on page 38).

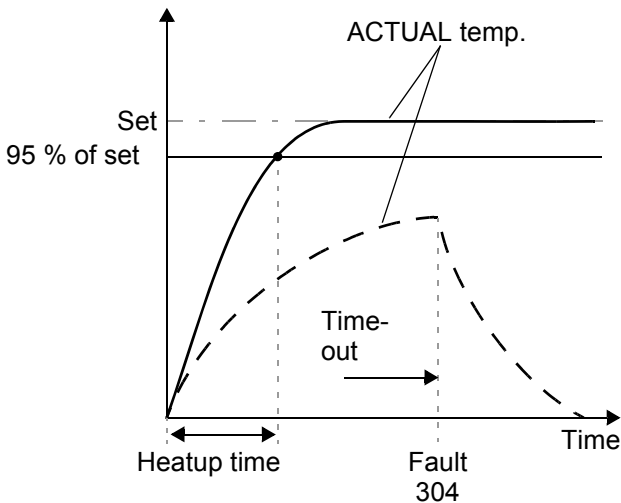

! The "heatup timeout" function must be activated by means of the parameter data (☞ section 10.7 "Parameter data" on page 29) (default setting: Heatup timeout off).

10.7.12 Hold mode

The behavior of the ACTUAL temperature indication via the PROFINET protocol can be configured by means of the parameter data (device master file) as follows:

1. "Off" (factory setting)
The ACTUAL temperature is always indicated in real time.
2. "On"
The ACTUAL temperature that was valid at the end of the last heatsealing phase is always indicated. When the controller is switched on, the real ACTUAL temperature is indicated until the end of the first heating phase.
3. "2 s"
This setting causes the current ACTUAL temperature to be displayed for an additional 2 seconds at the end of a heatsealing phase by means of the PROFINET protocol. The ACTUAL temperature is then indicated again in real time until the end of the next heatsealing phase.

! Hold mode only applies to the ACTUAL temperature indication via the PROFINET communication and the digital temperature display in the ROPEX visualization software. It has no effect on the ACTUAL temperature that appears at the controller's analog output or is recorded in the graphics window of the ROPEX visualization software.

The various hold modes are shown below:

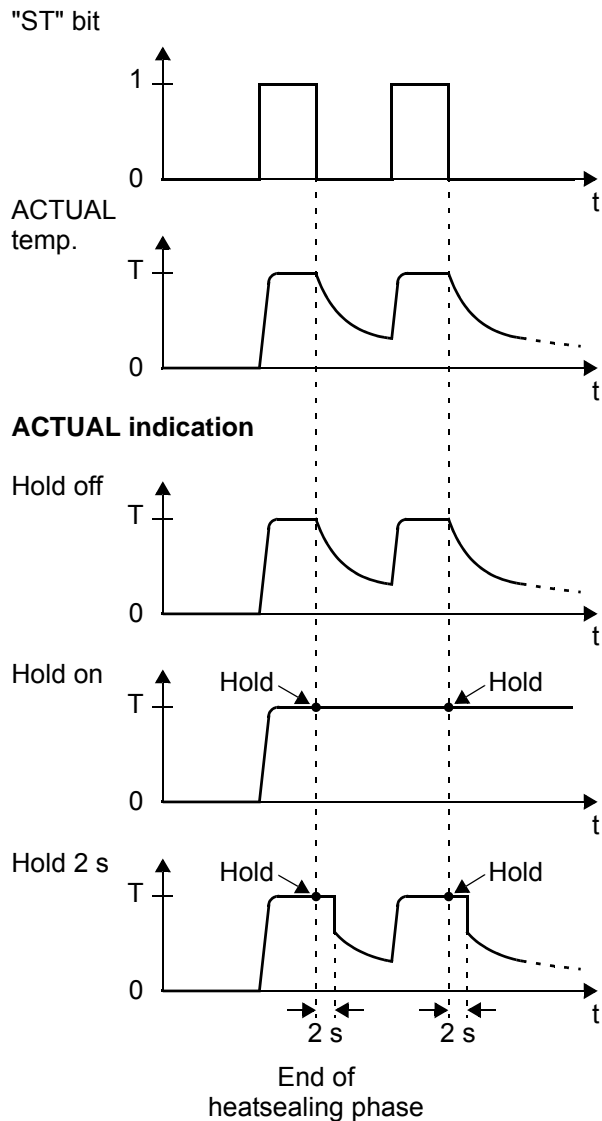

! The "hold mode" function must be activated by means of the parameter data (☞ section 10.7 "Parameter data" on page 29). (Default setting: Hold mode off).

10.8 Undervoltage detection

Trouble-free operation of the temperature controller is guaranteed within the line voltage and 24VDC supply voltage tolerances specified in section 6 "Technical data" on page 8.

If the 24VDC supply voltage drops below the permitted lower limit, the controller is switched to standby mode. No more heatsealing processes take place and no more measuring impulses are generated. Normal operation is resumed when the input voltage returns to the specified tolerance range again.

Standby mode is indicated by 0...3 °C (i.e. approx. 0V) at the analog output.

! Trouble-free operation of the controller is only guaranteed within the specified tolerance range of the input voltage. An external voltage monitor must be connected to prevent defective heatseals due to low line or 24VDC supply voltage.

10.9 Temperature indication (actual value output)

The RES-5010 supplies an analog 0...10VDC signal, which is proportional to the real ACTUAL temperature, at terminals 17+18.

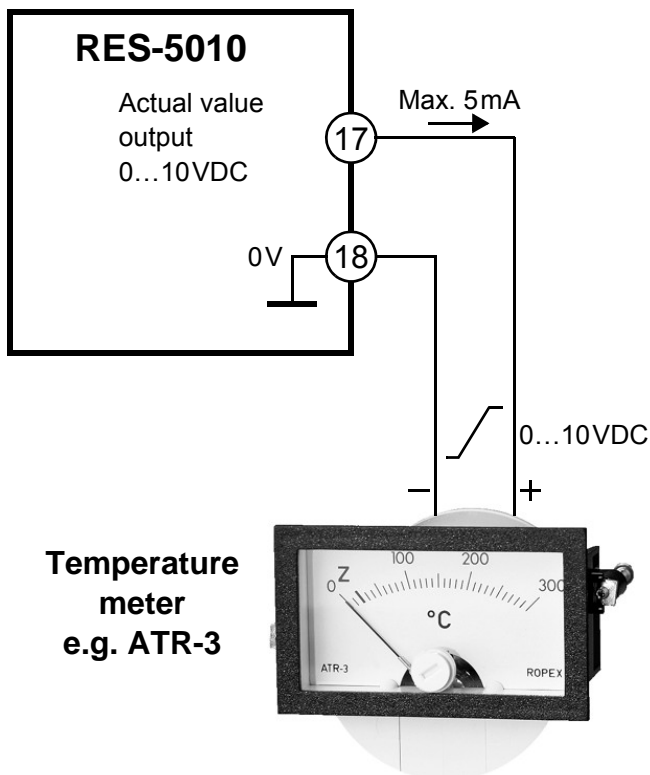

Voltage values:

0VDC → 0 °C

10VDC → 300 °C or 500 °C

(depending on the controller configuration).

The relationship between the change in the output voltage and the ACTUAL temperature is linear.

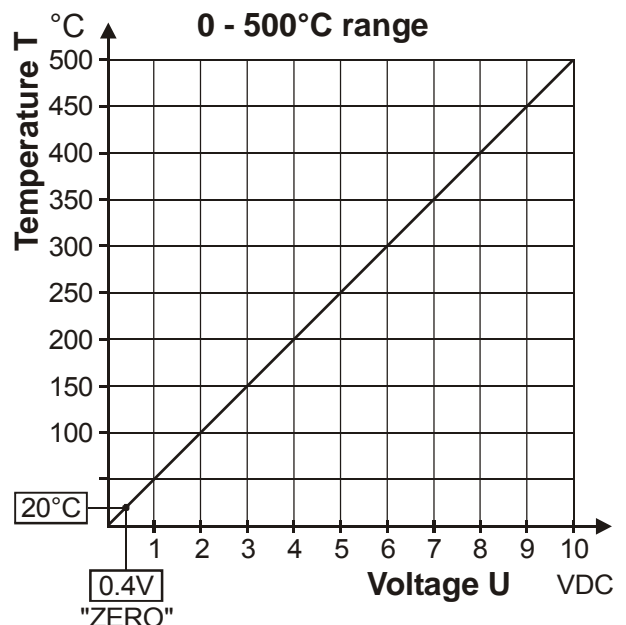
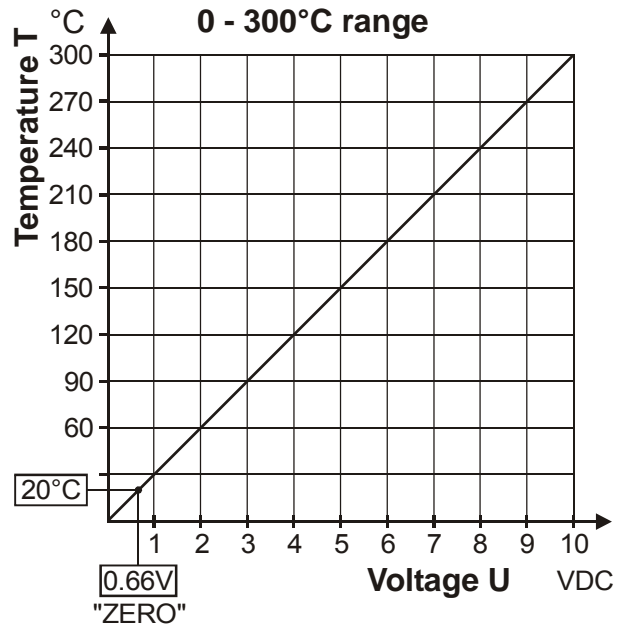

An indicating instrument can be connected to this output in order to visualize the temperature of the heatsealing band.

The characteristics of the ROPEX ATR-x temperature meter (size, scaling, dynamic response) are ideally suited to this application and this instrument should

therefore always be used (↪ section 5 "Accessories and modifications" on page 6).

The meter not only facilitates SET-ACTUAL comparisons but also enables other criteria such as the heating rate, set point reached within the specified time, cooling of the heatsealing band etc. to be evaluated.

The temperature meter additionally permits disturbances in the control loop (loose connections, contacting or wiring problems) as well as any line disturbances to be observed extremely effectively and interpreted accordingly. The same applies if mutual interference occurs between several neighboring control loops.

 **This output is not potential-free and could carry the secondary voltage of the impulse transformer. External grounding is not allowed. If this warning is ignored, the controller will be damaged by frame currents. Contact voltage protection must be installed at the terminals of the external temperature meter.**

If a fault is signaled, this analog output is used to display a selective error message (↪ section 10.17 "Error messages" on page 38).

10.10 Booster connection

The RES-5010 controller has a connection for an external switching amplifier (booster) as standard. This connection (at terminals 15+16) is necessary for high primary currents (continuous current > 5A, pulsed current > 25A). The switching amplifier should be connected as described in section 8.7 "Wiring diagram with booster connection" on page 16.

 **The connecting cable to the external switching amplifier must not be longer than 1 m; it must also be twisted in order to reduce EMC interference to a minimum.**

10.11 Diagnostic interface / visualization software

An interface with a 6-pole Western socket is provided for system diagnostics and process visualization. This interface allows a data connection to be set up to the ROPEX visualization software using the ROPEX CI-USB-1 communication interface.

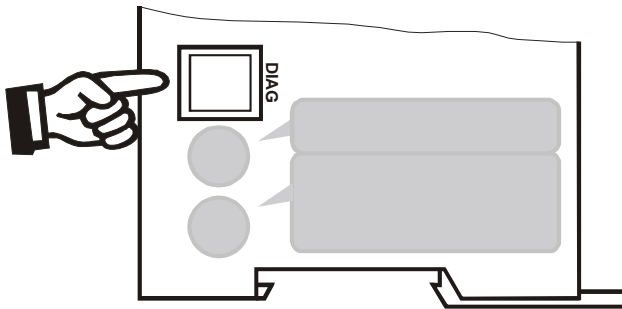

! Only a ROPEX communication interface is allowed to be connected to the diagnostic interface. Connecting another device (e.g. a telephone cable) could result in malfunctions or damage to the controller.

The ROPEX visualization software is described in a separate document.

10.12 Total cycle counter

The number of heatsealing cycles executed since the controller was first delivered is stored internally ("ST" bit = 1). This counter can only be displayed and not reset. It can only be displayed using the ROPEX visualization software (↪ section 10.11 "Diagnostic interface / visualization software" on page 36).

10.13 Operating hours counter

The number of operating hours since the controller was first delivered is stored internally. This counter works with a resolution of six minutes. It can only be displayed and not reset. It can only be displayed using the ROPEX visualization software (↪ section 10.11 "Diagnostic interface / visualization software" on page 36).

10.14 Data memory for error messages and AUTOCAL

To simplify error diagnoses during operation, the RES-5010 controller has a data memory for error messages (↪ section 10.17 "Error messages" on page 38) and executed AUTOCAL functions (↪ section 10.5.1 "Automatic zero calibration "AUTOCAL" (AC)" on page 26).

The 200 most recent messages are stored. They can be read out and displayed using the ROPEX visualization software (↪ section 10.11 "Diagnostic interface / visualization software" on page 36).

The RES-5010 also features an integrated clock (↪ section 10.15 "Integrated clock (date and time)" on page 36). All messages are saved in the data memory together with their date and time of occurrence (time stamp).

10.15 Integrated clock (date and time)

The RES-5010 has an integrated clock. All messages are saved in the data memory (↪ section 10.14 "Data memory for error messages and AUTOCAL" on page 36) together with their date and time of occurrence (time stamp). Error messages can thus be interpreted more accurately, for instance in order to analyze a problem.

The integrated clock can only be set and read out using the ROPEX visualization software (↪ section 10.11 "Diagnostic interface / visualization software" on page 36).

! The clock is operated by means of a maintenance-free capacitor. There is no battery that has to be replaced.

The controller must remain switched on for at least three hours to make sure the clock's capacitor is fully charged. When the controller is switched off, the fully charged capacitor can keep the clock running for approx. 4...6 weeks. If the controller is switched off for longer, the date and time will have to be set again. You do this using the ROPEX visualization software (↪ section 10.11 "Diagnostic interface / visualization software" on page 36).

! The capacitor is not charged when it leaves the factory. When the controller is started up, you must set the clock if you want error messages in the data memory (↪ section 10.14 "Data memory

for error messages and AUTOCAL" on page 36) to be saved together with their date and time of occurrence.

! The controller can also be operated without setting the clock. In this case, the date and time values that are saved in the data memory will not be valid (↪ section 10.14 "Data memory for error messages and AUTOCAL" on page 36). This has no effect on the temperature control functions.

10.16 System monitoring / alarm output

To increase operational safety and avoid faulty heatsealing, this controller incorporates special hardware and software features that facilitate selective error detection and diagnosis. Both the external wiring and the internal system are monitored.

These features assist the operator in identifying the cause of abnormal conditions.

A system fault is reported or differentiated by means of the following indications.

A.) Red "ALARM" LED on the controller with three states:

1. BLINKS fast (4Hz):

The AUTOCAL function should be executed (error codes 104...106, 211, 302, 303).

2. BLINKS slowly (1Hz):

The system configuration is incorrect and the zero calibration (AUTOCAL function) was unsuccessful (↪ section 9.2 "Controller configuration" on page 17). This corresponds to error codes 111...114).

3. Lit continuously:

A fault is preventing the controller from being started (error codes 101...103, 107, 108, 201...203, 304, 307, 308, 9xx).

As a rule, this refers to an external wiring fault.

B.) Fault relay (relay contact terminals 12+13+14):

This relay is set at the factory as follows:

- **DE-ENERGIZED** in operating states A.1 and A.2 but energized if a "START" signal is present in one of these states.
- **ENERGIZED** in operating state A.3.

If the fault relay has the opposite configuration to the factory setting (↪ section 9.2.3 "Configuration of the

rotary coding switches for station names" on page 18), these states are reversed.

C.) Error code indicated via the PROFINET protocol

If an error occurs, the "AL" bit is set and possibly also the "WA" bit. The error code is contained in the third word at bit positions 0...9 (↪ section 10.6.9 "Error codes" on page 29).

D.) Error code indicated via the actual value output 0...10VDC (terminals 17+18):

Since a temperature indication is no longer necessary if a fault occurs, the actual value output is used to display error messages in the event of a fault.

Thirteen voltage levels are available for this purpose in the 0...10VDC range, each of which is assigned an error code (↪ section 10.17 "Error messages" on page 38).

If a state that requires AUTOCAL occurs – or if the controller configuration is not correct – (error codes 104...106, 111...114, 211, 302, 303), the signal at the actual value output jumps back and forth at 1Hz between the voltage value corresponding to this error and the end of the scale (10VDC, i.e 300°C or 500°C). If the "ST" bit is set in one of these states, the voltage value does not change any more.

Selective fault detection and indication can thus be implemented simply and inexpensively using the analog input of a PLC with a corresponding error message (↪ section 10.17 "Error messages" on page 38).

If there is a ROPEX analog temperature meter (i.e ATR-x) connected to the analog output of the controller, then the displayed temperature can be matched directly with the error code in case of an alarm. The table below shows the correlation between voltage level, displayed temperature und error code.

Temperature range 300°C [°C]	Temperature range 500°C [°C]	Act. value output voltage [V]	Error code
20	33	0,66	1
40	66	1,33	2
60	100	2,00	3
80	133	2,66	4
100	166	3,33	5
120	200	4,00	6

Temperature range 300°C [°C]	Temperature range 500°C [°C]	Act. value output voltage [V]	Error code
140	233	4,66	7
↔ 160 ↔ ↔ 300 ↔	↔ 266 ↔ ↔ 500 ↔	↔ 5,33 ↔ ↔ 10 ↔	8
↔ 180 ↔ ↔ 300 ↔	↔ 300 ↔ ↔ 500 ↔	↔ 6,00 ↔ ↔ 10 ↔	9
↔ 200 ↔ ↔ 300 ↔	↔ 333 ↔ ↔ 500 ↔	↔ 6,66 ↔ ↔ 10 ↔	10
↔ 220 ↔ ↔ 300 ↔	↔ 366 ↔ ↔ 500 ↔	↔ 7,33 ↔ ↔ 10 ↔	11
↔ 240 ↔ ↔ 300 ↔	↔ 400 ↔ ↔ 500 ↔	↔ 8,00 ↔ ↔ 10 ↔	12
↔ 260 ↔ ↔ 300 ↔	↔ 433 ↔ ↔ 500 ↔	↔ 8,66 ↔ ↔ 10 ↔	13

 **An error message can only be reset by setting the "RS" bit or by momentarily interrupting the power to the controller (24VDC supply voltage).**

 **If an error message is reset using the "RS" bit, it is not reset until the "RS" bit is reset.**

 **Invalid error messages may appear when the controller is switched off owing to the undefined operating state. This must be taken into account when they are evaluated by the higher-**

level controller (e.g. a PLC) in order to avoid false alarms.

10.17 Error messages

In addition to the error diagnosis which is coded in the protocol, you can also access the PROFINET diagnosis function (extended controller diagnosis). The error codes appear in the configuring tool in plain text because they are stored in the device master file.

The table below shows the meaning of the error codes. It includes a description of each error and the required corrective action.

The block diagram in section 10.18 "Fault areas and causes" on page 41 enable a particular error to be cleared quickly and efficiently.

Thirteen voltage levels for diagnosing errors appear at the controller's actual value output. The error messages are differentiated even more finely in the controller. The 3-digit error numbers described below can be displayed via the PROFINET interface and using the ROPEX visualization software (↪ section 10.11 "Diagnostic interface / visualization software" on page 36) to facilitate troubleshooting.

 **If the actual value output is evaluated in order to identify an error message – in the higher-level controller, for instance – the tolerance window must be adjusted to prevent it from being incorrectly interpreted. Please note the tolerances of the actual value output (↪ section 6 "Technical data" on page 8).**

Teil 1 von 3: Error messages (faults)						
NOTE: The specified error messages are initially output as faults (stable error voltage level at the actual value output; alarm LED lit continuously; alarm relay is energized).						
Error code		Act. value output; Voltage [V]	Caus	Action if machine started for first time	Action if machine already operating, HS band not chang.	
1	101	0,66	I _R signal missing	Fault area ①	Fault area ①	
2	102	1,33	U _R signal missing	Fault area ③	Fault area ③	
3	103	2,00	U _R and I _R signals missing	Fault area ②	Fault areas ②⑨	
4	107	2,66	Temperature step down	Fault areas ④⑤⑥ („loose contact“)	Fault areas ④⑤⑥ („loose contact“)	
	108		Temperature step up			
	307		Temperature too low/high (↪ section 10.7.10)			
	308					
	309					
	310					
5	201	3,33	Line frequency is missing	Check power supply	Check power supply	
	202		Line frequency too high/fluctuates			
	203		Line frequency too low/fluctuates			
6	304	4,00	Heatup time too long (↪ section 10.7.11)	Run RESET	Run RESET	
7	901	4,66	No line voltage/Sync-Sig.	↪ chap. 10.2	↪ chap. 10.2	
	913		Triac defective	Replace controller	Replace controller	
	914		Internal fault, controller defective	Replace controller	Replace controller	
	915					
	916					
	917		Plug-in jumper for alarm output wrong	Check Plug-in jumper	Check Plug-in jumper	
918						

Teil 2 von 3: Error messages (warnings)

NOTE: The specified error messages are initially output as warnings (actual value output jumps back and forth between two values; alarm LED blinks; alarm relay is de-energized). When the "START" signal is activated, the warning changes to a fault (actual value output no longer jumps back and forth, see ***bold italic values***; alarm LED lit continuously; alarm relay is energized).

Error code	Act. value output; Voltage [V]	Caus	Action if machine started for first time	Action if machine already operating, HS band not chang.
8	104	I _R signals incorrect, incorrect specification of impulse-transformer	Run AUTOCAL , Check specification of transformer, Fault areas ⑦⑧	Fault areas ④⑤⑥ (loose contact)
	105	U _R signals incorrect, incorrect specification of impulse-transformer		
	106	U _R and/or I _R signals incorrect, incorrect specification of impulse-transformer		
	302	Temperature too low, AUTOCAL wasn't performed, loose contact, ambient temp. fluctuates	Run AUTOCAL and/or fault areas ④⑤⑥ (loose contact)	
	303	temperature too high, AUTOCAL wasn't performed, loose contact, ambient temp. fluctuates		
9	↔ 6,00 ↔ ↔ 10 ↔	Data error	Run AUTOCAL	Run AUTOCAL

Teil 3 von 3: Error messages (warnings)

NOTE: The specified error messages are initially output as warnings (actual value output jumps back and forth between two values; alarm LED blinks; alarm relay is de-energized). When the "START" signal is activated, the warning changes to a fault (actual value output no longer jumps back and forth, see **bold italic values**; alarm LED lit continuously; alarm relay is energized).

Error code	Act. value output; Voltage [V]	Cause	Action if machine started for first time	Action if machine already operating, HS band not chang.
10 111	<i>6,66</i> ↕ 10 ↕	I _R signal incorrect, calibration not possible	Fault area ⑧, check configuration	Fault areas ④ ⑤ ⑥ (loose contact)
11 112	<i>7,33</i> ↕ 10 ↕	U _R signal incorrect, calibration not possible	Fault area ⑦, check configuration	Fault areas ④ ⑤ ⑥ (loose contact)
12 113	<i>8,00</i> ↕ 10 ↕	U _R and I _R signals incorrect, calibration not possible	Fault areas ⑦ ⑧, check configuration	Fault areas ④ ⑤ ⑥ (loose contact)
13	<i>8,66</i> ↕ 10 ↕	Temperature fluctuates, calibration not possible	Run AUTOCAL and/or Fault areas ④ ⑤ ⑥ (loose contact)	Run AUTOCAL and/or Fault areas ④ ⑤ ⑥ (loose contact)
		Ext. calibration temperature too high, calibration not possible	Run AUTOCAL with external calibration temperature ≤40°C	Run AUTOCAL with external calibration temperature ≤40°C
		Ext. calibration temperature fluctuates, calibration not possible	Run AUTOCAL with stabil external calibration temperature	Run AUTOCAL with stabil external calibration temperature

10.18 Fault areas and causes

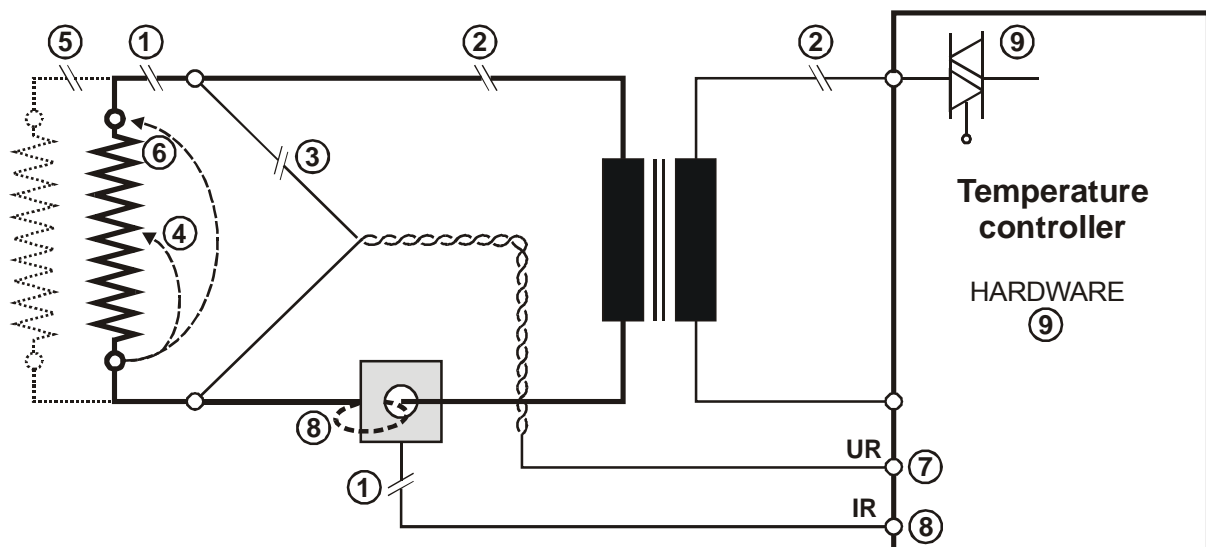

The table below explains the possible fault causes.

Fault area	Explanation	Possible causes
①	Load circuit interrupted after U_R pickoff point	- Wire break, heatsealing band break - Contact to heatsealing band is defective
	PEX-W2/-W3 current transformer signal interrupted	- I_R measurement cable from current transformer interrupted
②	Primary circuit interrupted	- Wire break, triac in controller defective - Primary winding of impulse transformer interrupted
	Secondary circuit interrupted before U_R pickoff point	- Wire break - Secondary winding of impulse transformer interrupted
③	No U_R signal	- Measurement cable interrupted
④	Partial short-circuit (ΔR)	- Heatsealing band partially bypassed by conducting part (clamp, opposite heatsealing bar etc.)
⑤	Parallel circuit interrupted	- Wire break, heatsealing band break - Contact to heatsealing band is defective
⑥	Total short-circuit	- Heatsealing band installed incorrectly, no insulation at heatsealing bar ends or insulation incorrectly installed - Heatsealing band completely bypassed by conducting part
⑦	U_R signal incorrect	- U_2 outside of permissible range from 0.4...120VAC
⑧	I_R signal incorrect	- I_2 outside of permissible range from 30...500A
	Turns through PEX-W2/-W3 current transformer incorrect	- Check number of turns (two or more turns required for currents < 30A)
⑨	Internal controller error / no line voltage	- Hardware fault (replace controller) - Jumper for fault relay not connected or incorrectly connected - No line voltage

11 Factory settings

The RES-5010 RESISTRON temperature controller is configured at the factory as follows:







<p><u>Rotary coding switch</u> for heatsealing band alloy and temperature range</p>	<table border="1" data-bbox="742 533 901 660"> <thead> <tr> <th>SWITCH POS.</th> <th>TE.</th> </tr> </thead> <tbody> <tr> <td>0</td> <td>300</td> </tr> <tr> <td>1</td> <td>300</td> </tr> <tr> <td>4</td> <td>500</td> </tr> <tr> <td>5</td> <td>500</td> </tr> <tr> <td>8</td> <td>300</td> </tr> <tr> <td>9</td> <td>PC</td> </tr> </tbody> </table>	SWITCH POS.	TE.	0	300	1	300	4	500	5	500	8	300	9	PC	<p>Heatsealing band alloy: Alloy A20 Temperature range: 300°C</p> <p>Rotary coding switch: „0“ position</p>
SWITCH POS.	TE.															
0	300															
1	300															
4	500															
5	500															
8	300															
9	PC															
<p><u>Jumper</u> for fault relay</p>	<table border="1" data-bbox="742 824 901 952"> <thead> <tr> <th>SWITCH POS.</th> <th>TE.</th> </tr> </thead> <tbody> <tr> <td>0</td> <td>300</td> </tr> <tr> <td>1</td> <td>300</td> </tr> <tr> <td>4</td> <td>500</td> </tr> <tr> <td>5</td> <td>500</td> </tr> <tr> <td>8</td> <td>300</td> </tr> <tr> <td>9</td> <td>PC</td> </tr> </tbody> </table>	SWITCH POS.	TE.	0	300	1	300	4	500	5	500	8	300	9	PC	<p>Fault relay is energized at alarm</p>
SWITCH POS.	TE.															
0	300															
1	300															
4	500															
5	500															
8	300															
9	PC															
<p><u>Automatic phase angle compensation</u> (AUTOCOMP)</p>		<p>AUTOCOMP: Off</p>														
<p><u>Temperature diagnosis</u></p>		<p>Temperatur diagnosis: Off</p>														
<p><u>Heatup timeout</u></p>		<p>Heatup timeout: Off</p>														

12 Maintenance

The controller requires no special maintenance. Regular inspection and / or tightening of the terminals – including the terminals for the winding connections on

the impulse transformer – is recommended. Dust deposits on the controller can be removed with dry compressed air.

13 How to order

	<p>Contr. RES - 5010 / . . . V AC</p> <ul style="list-style-type: none"> ↳ 115: Power supply 115VAC, Art. No. 7501001 ↳ 230: Power supply 230VAC, Art. No. 7501002 ↳ 400: Power supply 400VAC, Art. No. 7501003 <p>Scope of supply: Controller includes connector plug-in parts (without current transformer)</p> <p>Modification MOD . . (optional, if required)</p> <ul style="list-style-type: none"> ↳ e.g. 01: MOD 01, Art. No. 800001 (amplifier for low voltage) <p>Please indicate the article numbers of the controller and the required modifications (optional) in all orders, e.g. RES-5010/400VAC + MOD 01 (controller for 400VAC power supply with amplifier for low voltage) Art Nos. 7501003 + 800001 must be ordered</p>
	<p>Current transformer PEX-W3 Art. No. 885105</p>
	<p>Line filter LF- . . 480</p> <ul style="list-style-type: none"> ↳ 06: Continuous current 6A, 480VAC, Art. No. 885500 ↳ 35: Continuous current 35A, 480VAC, Art. No. 885506
	<p>Impulse transformer</p> <p>See ROPEX Application Report for design and ordering information</p>
	<p>Communication interface CI-USB-1 Art. No. 885650</p>
	<p>Temp. meter ATR - .</p> <ul style="list-style-type: none"> ↳ 3: 300°C range, Art. No. 882130 ↳ 5: 500°C range, Art. No. 882150
	<p>Booster B- . . . 400</p> <ul style="list-style-type: none"> ↳ 075: Max. pulse load 75A, 400VAC, Art. No. 885301 ↳ 100: Max. pulse load 100A, 400VAC, Art. No. 885304

14 Index

Nummern

24VDC supply voltage 8

A

"AA" bit 27
 "AC" bit 26
 Actual value 29
 Actual value output 34
 "AG" bit 28
 "AL" bit 20, 28
 Alarm output 37
 Alloy 18, 21
 Ambient temperature 9
 Analog temperature meter 6
 Anschlussbild 15, 16
 Application 4
 Application Report 11, 14
 AUTOCAL 6, 20
 Active 27
 Disabled 26, 28
 Starting 26
 AUTOCOMP 31
 Automatic phase angle compensation 31
 Automatic zero calibration 6, 20, 26
 AUTOTUNE 6

B

Booster 7, 16, 44
 Booster connection 35
 Burning in heatsealing band 19, 21

C

Circuit-breaker 13
 CI-USB-1 7, 36, 44
 Clock 36
 Communication interface 7, 36, 44
 Controller active 29
 Current transformer 14, 44

D

Data format 31
 Data memory 36
 Date 36
 Degree of protection 9
 Device master file (GSDML) 24
 Diagnostic interface 36
 Dimensions 10

E

Error code format 31
 Error diagnosis 6
 Error messages 38
 Extended controller diagnosis 31

External switching amplifier 7, 16

F

Factory settings 43
 Fault 28
 Fault relay 9, 19
 Fehlerbereiche 41
 Fuse 13

G

GSDML file 24

H

Heatsealing band type 8
 Heatup timeout 32

I

Impulse heatsealing method 4
 Impulse transformer 7, 13, 44
 Input data 25
 Installation 9, 11
 Installation procedure 11
 Installation regulations 11

L

Line filter 6, 13, 14, 44
 Line frequency 6, 8
 Line voltage 8

M

Maintenance 43
 Measurement cable 7
 Measurement pause 27
 Measuring impulse duration 31
 Measuring range 8
 Modification MOD 7, 44
 "MP" bit 27

O

Operating hours counter 36
 Output data 27
 Over-current protection 13
 Overheating of heatsealing band 6

P

PEX-W2/-W3 3
 PEX-W3 14, 44
 Phase angle compensation 31
 Power dissipation 9
 Power supply 13, 44
 Power supply system 8
 PROFINET interface 8

R

"RA" bit 21, 29
Replacing the heatsealing band 19, 21
Reset 27
"RS" bit 27

S

Set point 27
Standby mode 34
Start 26
"START" bit 21
Startup 17
System diagnosis 36
System monitoring 37

T

TCR 3, 19
"TE" bit 28
Temperature coefficient 3, 19

Temperature control 4
Temperature diagnosis 32
Temperature meter 6, 34, 44
Temperature OK 28
Temperature range 8, 18
Temperature reached 28
Time 36
Time stamp 36
"TO" bit 28
Total cycle counter 36
Transformer 3, 7, 13, 44
Type of construction 8

V

View of the controller 17
Visualization software 36

W

Wiring 11, 13